

N Series

High Density Mini-Modular Connectors

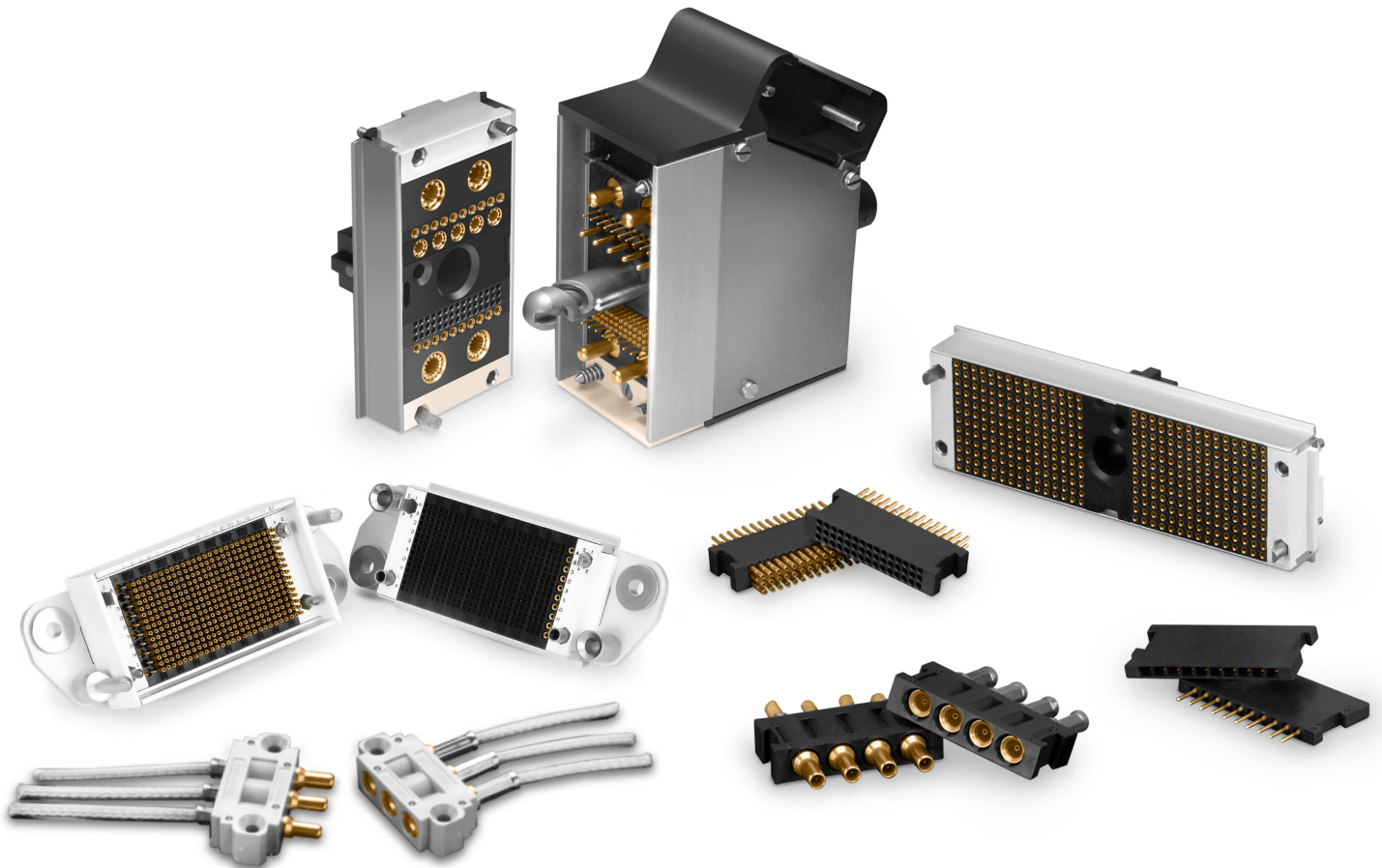

Hyperboloid Technology

Smiths Interconnect offers an extensive range of superior contact technologies suitable for standard and custom solutions. Hypertac® (HYPERboloid conTACT) is the original superior performing hyperboloid contact technology designed for use in all applications and in harsh and demanding environments where high reliability and safety are critical. The inherent electrical and mechanical characteristics of the Hypertac hyperboloid contact ensures unrivalled performance in terms of reliability, number of mating cycles, low contact force and minimal contact resistance. The shape of the contact sleeve is formed by hyperbolically arranged contact wires, which align themselves elastically as contact lines around the pin, providing a number of linear contact paths.

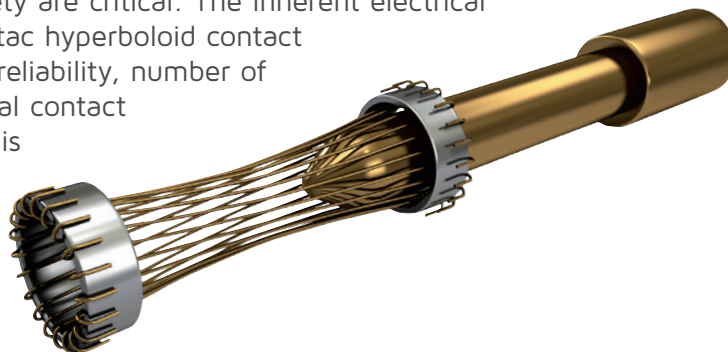

Features	Benefits
Low insertion/extraction forces The angle of the socket wires allows tight control of the pin insertion and extraction forces. The spring wires are smoothly deflected to make line contact with the pin.	High density interconnect systems Significant reductions in size and weight of sub-system designs. No additional hardware is required to overcome mating and un-mating forces.
Long contact life The smooth and light wiping action minimizes wear on the contact surfaces. Contacts perform up to 100,000 insertion/extraction cycles with minimal degradation in performance.	Low cost of ownership The Hypertac contact technology will surpass most product requirements, thus eliminating the burden and cost of having to replace the connector or the entire subsystem.
Lower contact resistance The design provides a far greater contact area and the wiping action of the wires insures a clean and polished contact surface. Our contact technology has about half the resistance of conventional contact designs.	Low power consumption The lower contact resistance of our technology results in a lower voltage drop across the connector reducing the power consumption and heat generation within the system.
Higher current ratings The design parameters of the contact (e.g., the number, diameter and angle of the wires) may be modified for any requirement. The number of wires can be increased so the contact area is distributed over a larger surface. Thus, the high current carried by each wire because of its intimate line contact, can be multiplied many times.	Maximum contact performance The lower contact resistance of the Hypertac contact reduces heat build-up; therefore Hypertac contacts are able to handle far greater current in smaller contact assemblies without the detrimental effects of high temperature.
Immunity to shock & vibration The low mass and resultant low inertia of the wires enable them to follow the most abrupt or extreme excursions of the pin without loss of contact. The contact area extends 360° around the pin and is uniform over its entire length. The 3 dimensional symmetry of the Hypertac contact design guarantees electrical continuity in all circumstances.	Reliability under harsh environments Harsh environmental conditions require connectors that will sustain their electrical integrity even under the most demanding conditions such as shock and vibration. The Hypertac contact provides unmatched stability in demanding environments when failure is not an option.

Contents

N Series	4
Features & Benefits	4
Frames:	
Frame B	5
Frame BV	6
Frame BY	7
Frame H	8
Frame JV	9
Frame JY 1	0
Modules:	
Technical Characteristics	11
Module H	12
Module K	13
Module P	14
Module T	15
Module V	16
Module V Coax	17
Accessories	18
Mounting Dimensions	19
How to Order	20

N Series Connectors



Smiths Interconnect's N Series high density, modular rack and panel connectors employ a do-it-yourself system based on the principle of building blocks. The N Series system is composed of two elements: modules and frames. Modules of various styles and contact types, including signal and coaxial, can be combined into custom arrangements within a single connector frame. This allows the user to build a connector that addresses and fulfills their exact requirements with off-the-shelf components.

Ideal for rugged and rack and panel applications, the N Series connectors utilize the unparalleled performance of Hypertac® hyperboloid contact technology to provide high cycle life, low insertion/extraction forces and immunity to shock and vibration. This ensures both smooth and easy mating and maximum performance in connectors with large quantities of contacts.

The contacts are mounted in small plastic blocks and are removable for easy assembly and repair. The frames which hold the modules in position range from basic, only consisting of two side rails and end caps, to more complex, including Jackscrews, hoods and cable clamps. To conform to almost any combination of modules, all frames are available in numerous lengths. With the N Series, specially designed connectors can be purchased quickly and inexpensively, eliminating the extra cost and delay of custom tooling.

Features and Benefits

Low insertion / extraction forces

High density interconnect systems

Reliability in harsh environments

- Immunity to shock and vibration
- Long contact life
- Minimal contact resistance
- Efficient power consumption

High current ratings

Low cost of ownership

Design flexibility

- Allows up to 900 contact positions
- Building block system composed of custom module combinations within a connector frame
- Keying system available
- Removable signal and coax contact types available
- Jackscrews available in half-turn quick disconnect
- Float mountable for blind mating

Cable to chassis, cable to cable and rack and panel applications

Applications

Rack and panel solutions

- Standard N Series
- Available keying system
- Available locking system
- Available float mounting

Cable solutions

- Hooded with rounded or flat cable security clamps
- Metal backshell with adjustable cable clamp
- Available jackscrew feature
- Full range of accessories offered

Market applications

- Test equipment
- Burn-in stands
- Security systems
- Medical equipment

Frames

Dimensions and Specifications

Frame B

Up to 775 Contacts

- Single row, rack and panel with keying
- Built-in pin protection on the plug frames
- 36 possible keying arrangements
- Standard sizes: 7, 11, 15, 19, 23, 27, 31 and 35 unit lengths
- Up to 35 contacts on 0.100 x 0.100 [2.54 x 2.54] centers

Units	X	Plug	Receptacle
7	1.000 [25.40]	NPB7	NEB7
11	1.400 [35.56]	NPB11	NEB11
15	1.800 [45.72]	NPB15	NEB15
19	2.200 [55.88]	NPB19	NEB19
23	2.600 [66.04]	NPB23	NEB23
27	3.000 [76.20]	NPB27	NEB27
31	3.400 [86.36]	NPB31	NEB31
35	3.800 [96.52]	NPB35	NEB35

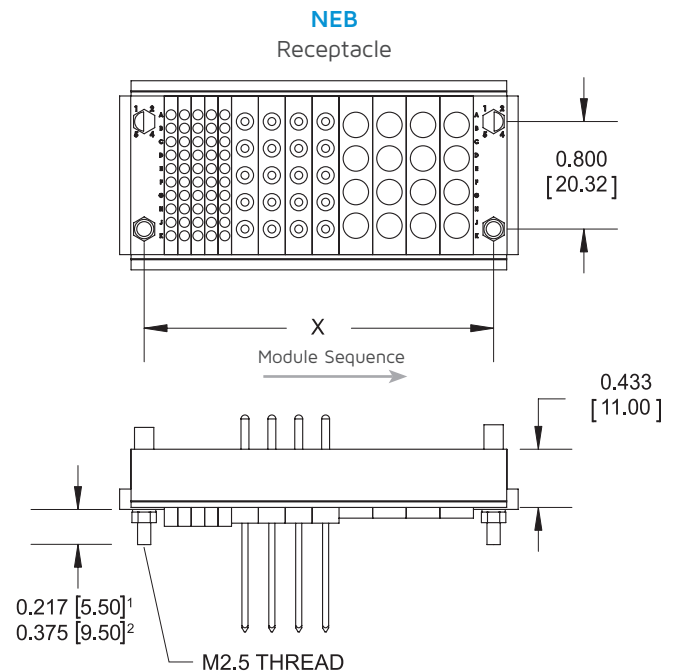
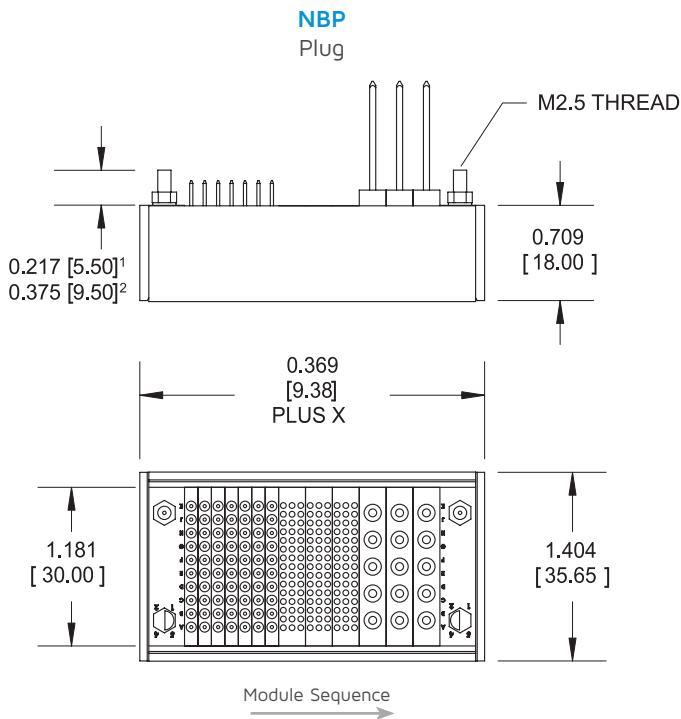

Notes: 1. Standard mounting stud length. 2. For thicker chassis, this longer mounting stud length can be selected by adding the modification code "-479" to the end of the connector part number. Dimensions are in inches [mm].

Frame BV

Up to 720 Contacts

- Threaded Jackscrew extractor
- 36 possible keying arrangements
- Standard sizes: 11, 15, 19, 23, 27, 31 and 35 unit lengths
- Up to 320 contacts on 0.100 x 0.100 [2.54 x 2.54] centers
- Built-in pin protection on the plug frames
- Allow 3 units for Jackscrew

Units	X	Plug	Receptacle
7	1.000 [25.40]	NPBV7	NEBV7
11	1.400 [35.56]	NPBV11	NEBV11
15	1.800 [45.72]	NPBV15	NEBV15
19	2.200 [55.88]	NPBV19	NEBV19
23	2.600 [66.04]	NPBV23	NEBV23
27	3.000 [76.20]	NPBV27	NEBV27
31	3.400 [86.36]	NPBV31	NEBV31
35	3.800 [96.52]	NPBV35	NEBV35

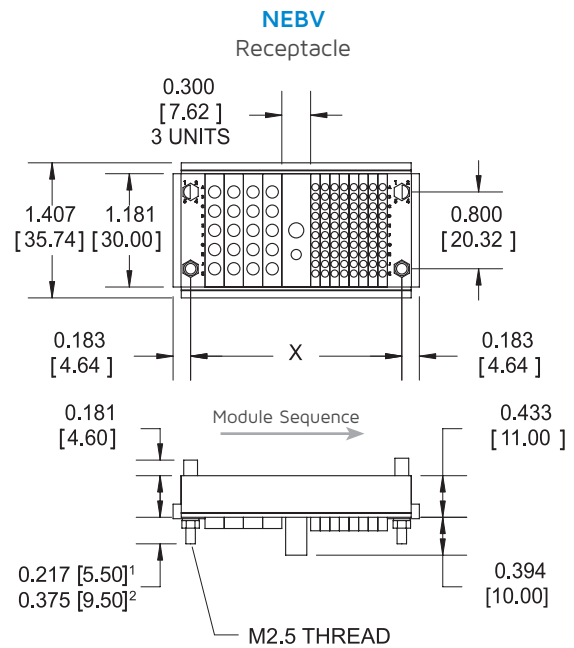
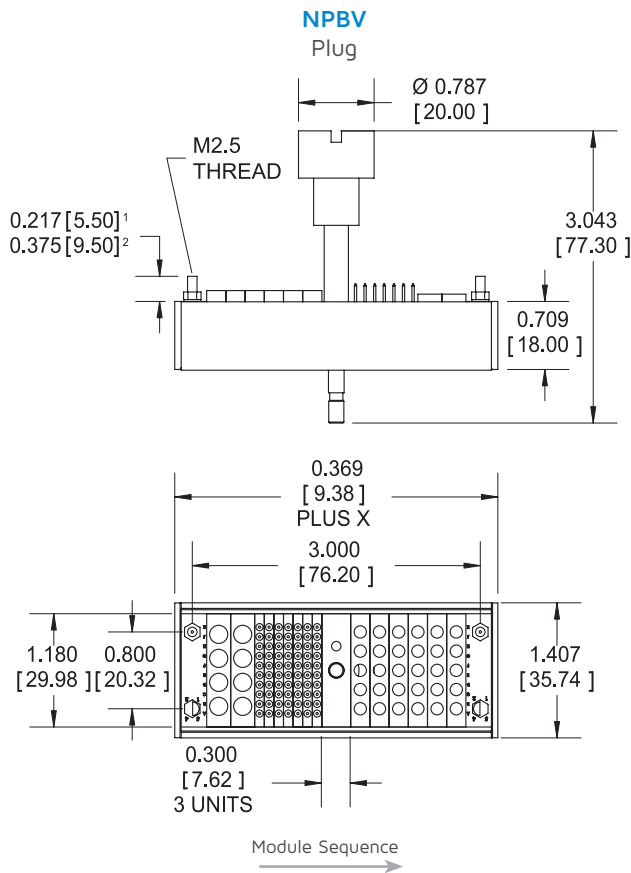

Notes: 1. Standard mounting stud length. 2. For thicker chassis, this longer mounting stud length can be selected by adding the modification code "-479" to the end of the connector part number. Dimensions are in inches [mm].

Frame BY

Up to 900 Contacts

- 180° quick turn jack provides greater than 15,000 mating cycles
- Great for test equipment, burn-in stands, security systems, and medical equipment
- Less than 1 second mating/unmating operation
- Crimp, solder cup, dip solder, and Wire Wrap® terminations
- Wiping action pin and socket
- Provides 20 to 400 contacts in a single mating
- 4 or 9 ampere contacts mixed to your needs
- Built-in pin protection on the plug frames
- Standard frame sizes: 11, 15, 19, 23, 27, 31, 35 and 45 unit lengths

Units	X	Plug	Receptacle
11	1.400 [35.56]	NPBY11	NEBY11
15	1.800 [45.72]	NPBY15	NEBY15
19	2.200 [55.88]	NPBY19	NEBY19
23	2.600 [66.04]	NPBY23	NEBY23
27	3.000 [76.20]	NPBY27	NEBY27
31	3.400 [86.36]	NPBY31	NEBY31
35	3.800 [96.52]	NPBY35	NEBY35
45	4.800 [121.92]	NPBY45	NEBY45

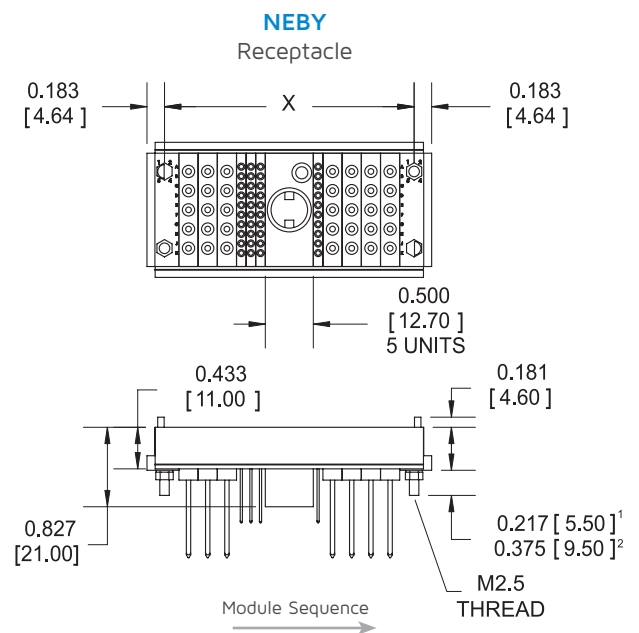
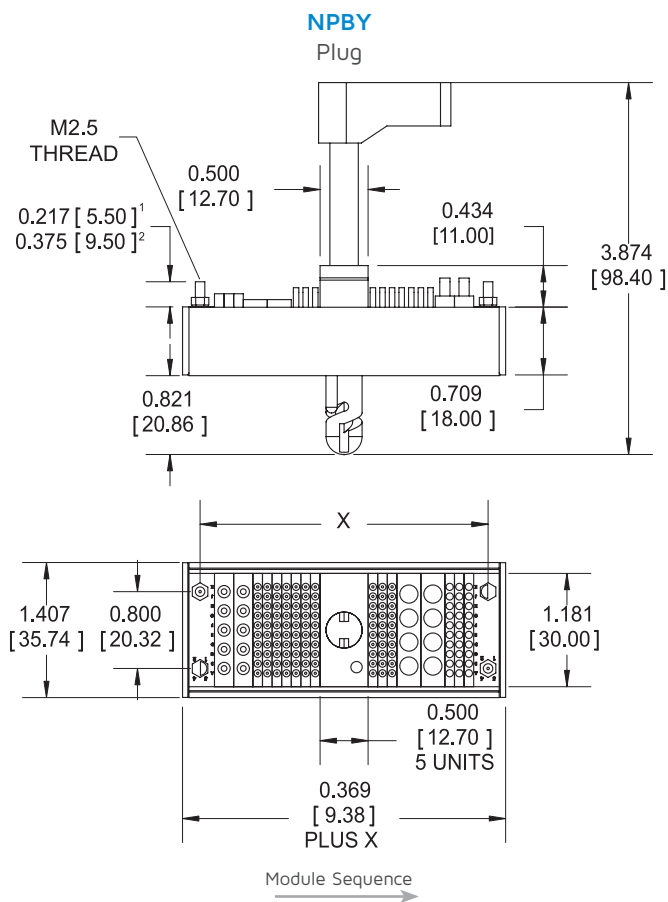

Notes: 1. Standard mounting stud length. 2. For thicker chassis, this longer mounting stud length can be selected by adding the modification code "-479" to the end of the connector part number. Dimensions are in inches [mm].

Frame H

Up to 775 Contacts

- Float mounting with heavy duty guides
- Max. radial play 0.049 [1.254] from centers
- Single row, rack and panel with keying
- Built-in pin protection on the plug frames
- 36 possible keying combinations
- Standard sizes: 7, 11, 15, 19, 23, 27, 31 and 35 unit lengths
- Up to 350 contacts on 0.100 x 0.100 [2.54 X 2.54] centers

 File No.: UL E102195

Units	Y	Plug	Receptacle
7	2.000 [50.80]	NPH7	NEBV7
11	2.400 [60.96]	NPH11	NEH11
15	2.800 [71.12]	NPH15	NEH15
19	3.200 [81.28]	NPH19	NEH19
23	3.600 [91.44]	NPH23	NEH23
27	4.000 [101.60]	NPH27	NEH27
31	4.400 [111.76]	NPH31	NEH31
35	4.800 [121.92]	NPH35	NEH35

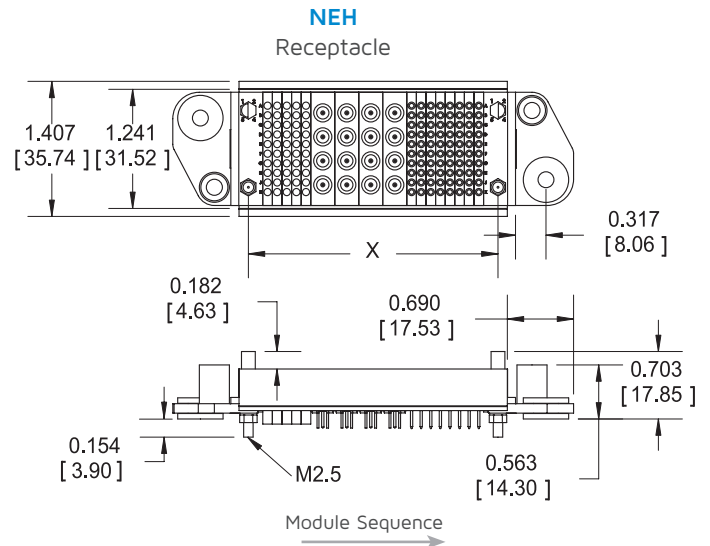
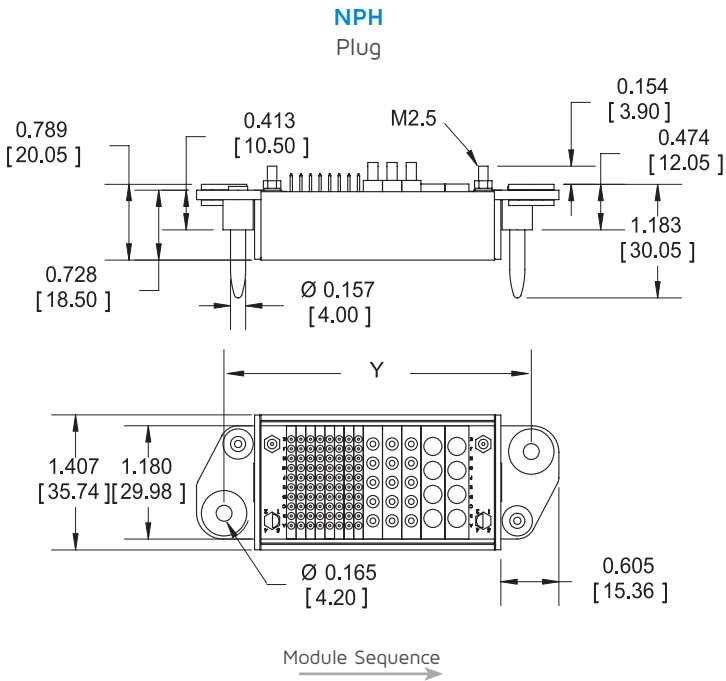

Frame JV Plug

Up to 775 Contacts

- Hooded with cable clamp
- Threaded Jackscrew extractor
- Single row, rack and panel with keying
- Built-in pin protection on the plug frames
- 36 possible keying combinations
- Standard sizes: 11, 15, 19, 23, 27, 31 and 35 unit lengths
- Up to 350 contacts on 0.100 x 0.100 [2.54 x 2.54] centers
- Jackscrew uses 3 units
- Adjustable cable clamp will hold 80 to 320 conductors of 22 to 28 AWG; adjusts 0.500 [12.70] to 1.00 [25.40] min.
- Refer to NEBV or NEPJV frame for mating receptacle
- Up to 320 contacts on 0.100 x 0.100 [2.54 x 2.54] centers

Units	Y	Z	Plug	Receptacle
11	1.993 [50.64]	0.884 [22.47]	NPJV11	NEJV11
15	2.393 [60.80]	1.084 [27.55]	NPJV15	NEJV15
19	2.794 [70.96]	1.284 [32.63]	NPJV19	NEJV19
23	3.194 [81.12]	1.484 [37.71]	NPJV23	NEJV23
27	3.594 [91.28]	1.684 [42.79]	NPJV27	NEJV27
31	4.000 [101.44]	1.884 [47.87]	NPJV31	NEJV31
35	4.393 [111.60]	2.084 [52.95]	NPJV35	NEJV35

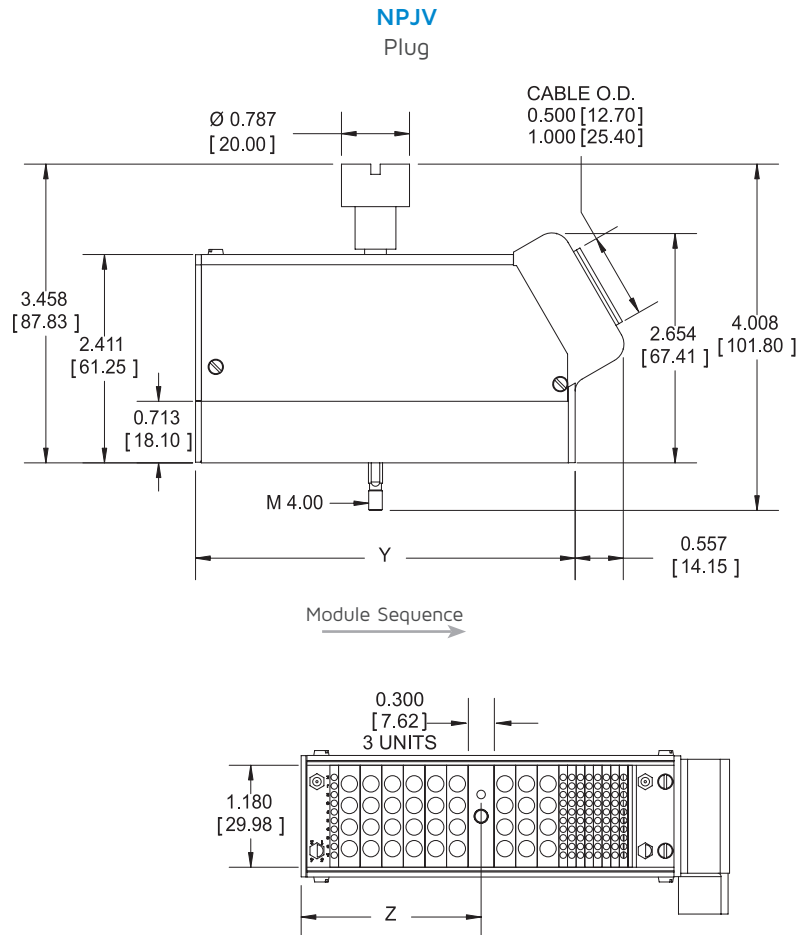

Notes: 1. Frame JV mates with NEBV or NEPJV. 2. Protective dust cover part number: YHD0369-XX (XX = number of units).
Dimensions are in inches [mm].

Frame JY

Up to 900 Contacts

- 180° quick turn jack provides greater than 15,000 mating cycles
- Great for test equipment, burn-in stands, security systems, and medical equipment
- Less than 1 second mating/unmating operation
- Crimp, solder cup, dip solder, and Wire Wrap® terminations
- Wiping action pin and sockets
- Provides 20 to 400 contacts in a single mating
- 4 or 9 ampere contacts mixed to your needs
- Built-in pin protection on the plug frames
- Standard frame sizes: 11, 15, 19, 23, 27, 31, 35 and 45 unit lengths
- Refer to NEBY or NEPJY frame for mating receptacle
- Adjustable Cable Clamp: 0.500 [12.70] to 1.00 [25.40]

Units	Y	Z	Plug	Receptacle
11	1.993 [50.64]	0.884 [22.47]	NPJY11	NEJY11
15	2.393 [60.80]	1.084 [27.55]	NPJY15	NEJY15
19	2.794 [70.96]	1.284 [32.63]	NPJY19	NEJY19
23	3.194 [81.12]	1.484 [37.71]	NPJY23	NEJY23
27	3.594 [91.28]	1.684 [42.79]	NPJY27	NEJY27
31	4.000 [101.44]	1.884 [47.87]	NPJY31	NEJY31
35	4.393 [111.60]	2.084 [52.95]	NPJY35	NEJY35
45	5.400 [137.16]	2.500 [63.50]	NPJY45	NEJY45

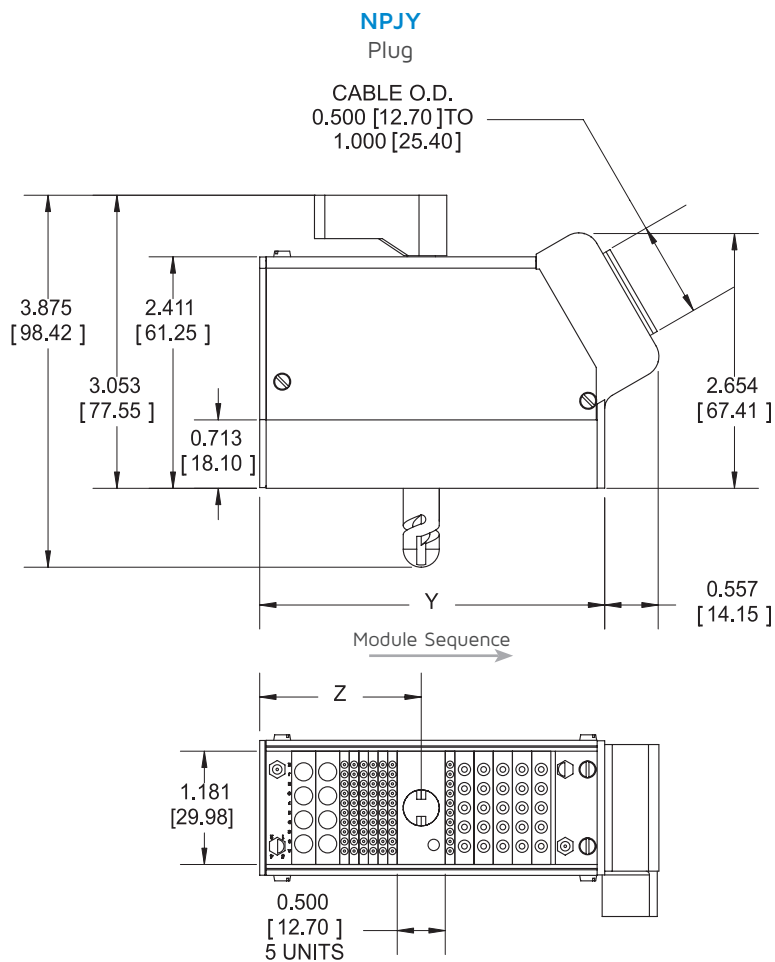

Notes: 1. Frame JY mates with NEBY or NEPJY. 2. Protective dust cover for plug only part number: ZMP0025-XX (XX = number of modules). Dimensions are in inches [mm].

Modules

Specifications and Ordering Information

Technical Characteristics

	H	K	P	T	V	V COAX
Current Rating	1 A	4 A	4 A	9 A	25 A ⁽¹⁾	—
Contact Resistance (mΩ)	< 8.0	< 5.0	< 5.0	< 2.5	< 1.5	< 8.0 / < 2.0 ⁽²⁾
Nominal Impedance	—					50 Ω
Frequency Range	—					DC 3 GHz to DC 18 GHz ⁽³⁾
Extraction Force (oz.) (per contact)	0.3 to 1.6*	0.5 to 2.0	0.5 to 2.0	0.7 to 5.0	3.0 to 17.0	1.5 to 6.0 (3.0 average)
Life Cycle	> 100,000 (contact)					> 25,000 (connector)
Breakdown Voltage (V RMS)	> 750	> 1,400	> 1,400	> 2,000	> 1,600	—
DWV (V RMS)	> 500	> 1,050	> 1,050	> 1,500	1,200	500
VSWR	—					< 1:20:1 (DC to 3 GHz) < 1:50:1 (3 to 18 GHz)
RF Transmission Loss	—					0.50 dB at 18 GHz
Insulation Resistance (MΩ at 500 VDC)	10 ³	10 ⁵	10 ³	10 ⁵	10 ⁴	> 5,000
Temperature Rating (°C)	-55 to 125	-55 to 105	-55 to 105	-55 to 105	-55 to 105	-55 to 125

Materials

Pin	Phosphor bronze		Brass			
Socket	Beryllium copper wires and brass body					
Insulator	Nylon, 25% glass	Glass filled nylon	Glass filled nylon	Glass filled nylon	Nylon	PTFE flouorocarbon

Contact Plating

Pin	10/50 μin gold over nickel			50 μin gold over nickel		
Socket Mating Surface	50 μin gold over nickel					
Socket Termination	Gold flash over nickel					
Socket Body (optional)	—	Nickel over copper flash	—	—	—	—

Notes: 1. 25 A (free air), 17 A (bundled) 2. Inner contact: < 8 mΩ; outer contact: < 2 mΩ 3. DC 3 GHz: RH316; DC 18 GHz: GH405
Dimensions are in inches [mm].

Module H

1 A Contact Rating

2 units, 45 Hypertac® hyperboloid crimp contacts, Ø 0.016 [0.40]

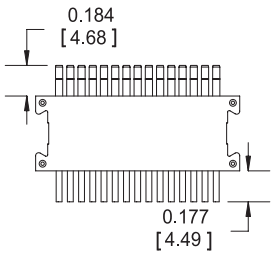
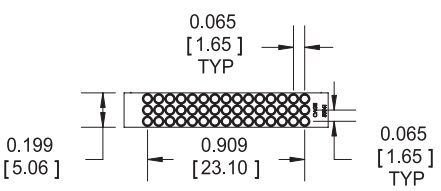
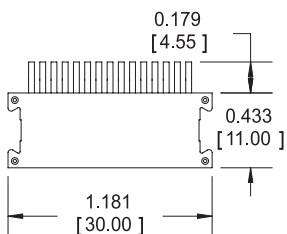
Module	Gender	Termination	Plating	Part Number	Replacement Contacts
 <p>NHF</p>	Female	Crimp 26-28 AWG	50 µin gold	NHFRTAH	YSK004-020AH
 <p>NHT</p>	Empty Block	—	—	NHH (ZNH045-001)	ZNH045-001
 <p>NHM</p>	Male	Crimp 26-28 AWG	50 µin gold 10 µin gold	NHMRT NHMRTH	YPN004-010H

Notes: 1. Male contacts are shrouded in the insulator, female mounts in the plug frame are suggested. 2. Crimp contacts will be shipped unassembled. Dimensions are in inches [mm].

Module K

4 A Contact Rating

1 unit, 10 Hypertac® hyperboloid removable signal contacts, Ø 0.024 [0.60]

File No.: UL E102195

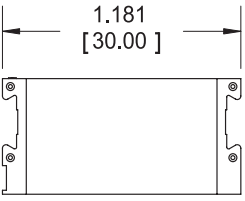
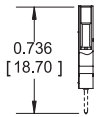
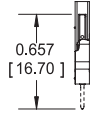
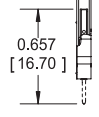
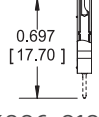
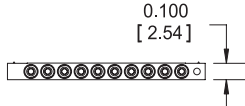
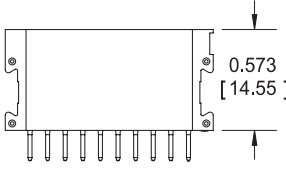
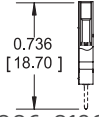
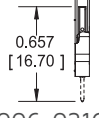
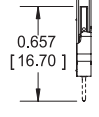
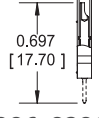
Module	Gender	Termination	Plating	Part Number	Replacement Contacts	HOLE	I.D.
 <p>NKF</p>	Female	Double Crimp 22-24 AWG	50 µin gold	NKFH2TAH	 YSK006-009AH	0.035 [0.90]	0.071 [1.80]
			50 µin gold, nickel over copper flash on socket body	NKFH2ANH			
		Crimp 22-26 AWG	50 µin gold	NKFRTAH	 YSK006-011ANH	0.035 [0.90]	0.051 [1.30]
			50 µin gold, nickel over copper flash on socket body	NKFRANH			
		Crimp 18-20 AWG	50 µin gold	NKFRRTAH	 YSK006-089AH	0.055 [1.39]	0.071 [1.80]
50 µin gold, nickel over copper flash on socket body	NKFRRANH						
Solder Cup 22 AWG	50 µin gold	NKFSTAH	 YSK006-010ANH	0.039 [1.00]	0.055 [1.40]		
	50 µin gold, nickel over copper flash on socket body	NKFSANH					
 <p>NKHT</p>	Empty Block	—	—	NKHT (ZNK010-001)	—	—	—
 <p>NKM</p>	Male	Double Crimp 22-24 AWG	10 µin gold	NKMH2T	 YPN006-019G or H	0.035 [0.90]	0.071 [1.80]
			50 µin gold	NKMH2TH			
		Crimp 22-26 AWG	10 µin gold	NKMRT	 YPN006-021G or H	0.035 [0.90]	0.051 [1.30]
			50 µin gold	NKMRTH			
		Crimp 18-20 AWG	10 µin gold	NKMRRT	 YPN006-158G or H	0.055 [1.39]	0.071 [1.80]
			50 µin gold	NKMRRTH			
		Solder Cup 22 AWG	10 µin gold	NKMST	 YPN006-020G or H	0.039 [1.00]	0.055 [1.40]
			50 µin gold	NKMSTH			

Notes: 1. Contacts will be shipped unassembled.
Dimensions are in inches [mm].

Module P

4 A Contact Rating

1 unit, 10 Hypertac® hyperboloid removable signal contacts, Ø 0.024 [0.60]

File No.: UL E102195

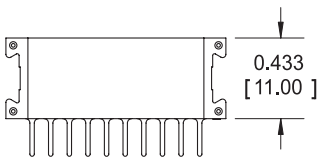
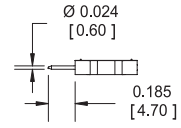
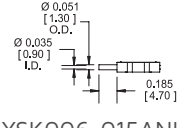
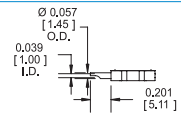
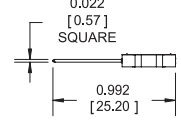
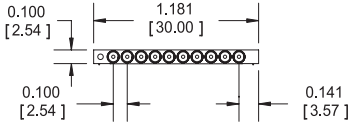
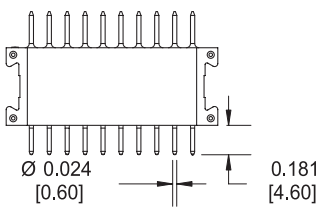
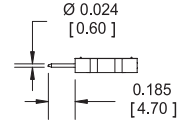
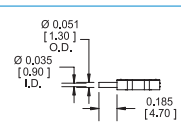
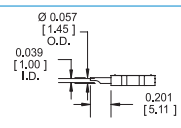
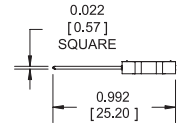
Module	Gender	Termination	Stripped Back	Plating	Part Number	Replacement Contacts	
 <p>NPF</p>	Female	Straight Solder Dip	—	50 µin gold	NPFDANH	 <p>YSK006-032ANH</p>	
				50 µin gold, nickel over copper flash on socket body	NPFDTAH		
		Crimp 22-24 AWG	0.173 [4.40]	50 µin gold	50 µin gold, nickel over copper flash on socket body	NPFRTAH	 <p>YSK006-015ANH</p>
						NPFRANH	
		Solder Cup 22 AWG	0.118 [3.30]	50 µin gold	50 µin gold, nickel over copper flash on socket body	NPFSTAH	 <p>YSK006-016ANH</p>
NPFSANH							
—	—	50 µin gold	50 µin gold, nickel over copper flash on socket body	NPFYTAH	 <p>YSK006-031ANH</p>		
NPFYANH							
 <p>NPHT</p>	Empty Block	—	—	—	NPHT (ZNP010-001)	—	
 <p>NPM</p>	Male	Straight Solder Dip	—	10 µin gold	NPMDT	 <p>YPN006-047G or H</p>	
				50 µin gold	NPMDTH		
		Crimp 22-24 AWG	0.173 [4.40]	10 µin gold	50 µin gold, nickel over copper flash on socket body	NPMRT	 <p>YPN006-025G or H</p>
						NPMRTH	
		Solder Cup 22 AWG	0.118 [3.30]	10 µin gold	50 µin gold, nickel over copper flash on socket body	NPMST	 <p>YPN006-026G or H</p>
						NPMSTH	
		—	—	10 µin gold	50 µin gold, nickel over copper flash on socket body	NPMYT	 <p>YPN006-046G or H</p>
						NPMYTH	

Notes: 1. Contacts will be shipped unassembled. 2. Crimping instructions: Doc. number 550063. Dimensions are in inches [mm].

Module T

9 A Contact Rating

2 units, 5 Hypertac® hyperboloid removable signal contacts, Ø 0.059 [1.50]

File No.: UL E102195

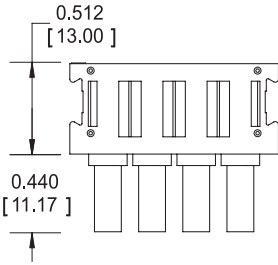
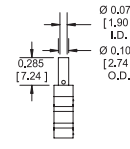
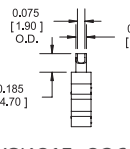
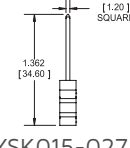
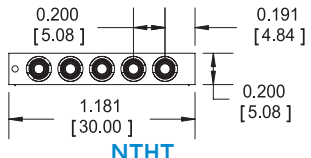
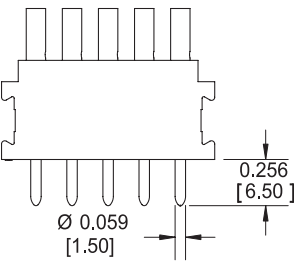
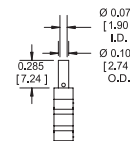
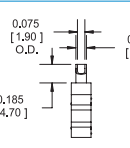
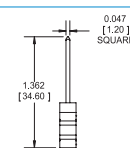
Module	Gender	Termination	Stripped Back	Plating	Part Number	Replacement Contacts
 <p>NTF</p>	Female	Crimp 14, 16, 10 & 20 AWG	0.285 [7.20]	50 µin gold	NTFRTAH	 <p>YSKO15-025AH</p>
		Solder Cup Up to 13 AWG	—	50 µin gold	NTFSTAHA	 <p>YSKO15-026AH</p>
		—	—	50 µin gold	NTFVTAHA	 <p>YSKO15-027AH</p>
 <p>NTHT</p>	Empty Block	—	—	—	NTHT (ZNT005-001)	—
 <p>NTM</p>	Male	Crimp 14, 16, 10 & 20 AWG	0.285 [7.20]	10 µin gold	NTMRT	 <p>YPNO15-016G or H</p>
				50 µin gold	NTMRTH	
		Solder Cup Up to 13 AWG	—	10 µin gold	NTMST	 <p>YPNO15-017G or H</p>
				50 µin gold	NTMSTH	
		—	—	10 µin gold	NTMVT	 <p>YPNO15-018G or H</p>
				50 µin gold	NTMVTH	

Note: Crimp contacts will be shipped unassembled.
Dimensions are in inches [mm].

Module V

25 A Power

2.5 units, 4 Hypertac® hyperboloid contacts. Can be mounted by itself or in a frame

 File No.: UL E102195

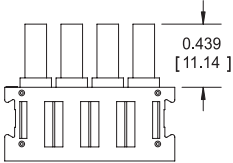
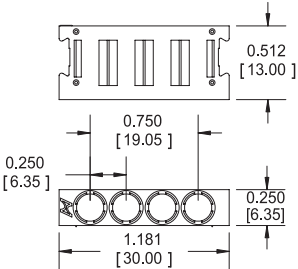
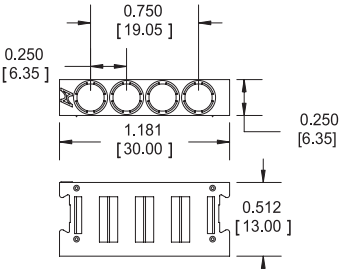
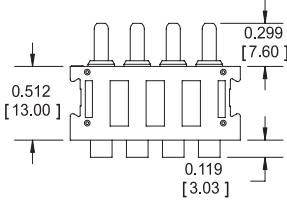
Module	Gender	Termination	Part Number	Replacement Contacts
 <p>NVF</p>	Female	Crimp 25 Amps (Free Air) 17 Amps (Bundled) 12-18 AWG	NVFP1TAH	YSK025-031AH
 <p>NVFH</p>	Female Empty Block	—	NVFH	—
 <p>NVMH</p>	Male Empty Block	—	NVMH	—
 <p>NVMP1TH</p>	Male	Crimp 25 Amps (Free Air) 17 Amps (Bundled) 12-18 AWG	NVMP1TH	YPN025-024H

Notes: Contacts shipped unassembled.
Dimensions are in inches [mm].

Module V

Coax

2.5 units, 4 Hypertac® hyperboloid contacts (on both signal and ground)

 File No.: UL E102195

Cabling	Crimp (R) and (R1)	Solder (S)
Cable	RG316 & RG316DB	RG405 & T-Flex 405
Socket	1.6 oz. at 4 units 2.5 oz. at 20 units	S50301 & S50307
Pin	S50304	S50303 & S50308

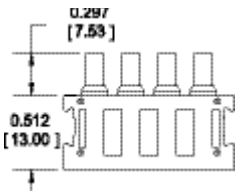
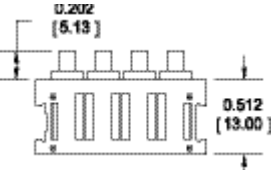
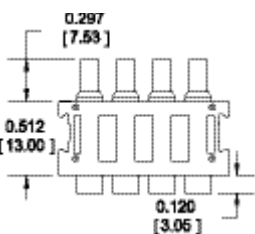
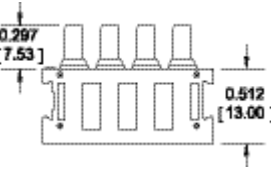
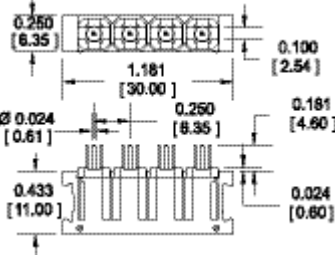
Module	Gender	Termination	Part Number	Replacement Contacts
 <p>NVF</p>	Female	Crimp Coaxial for RG316	NVFR1AH	YCX0315-002AH
		Crimp Coaxial for RG316DB	NVFR1TAH	YCX0315-019AH
 <p>NVF</p>	Female	Solder Coaxial for RG405 or T-Flex 405	NVFASTAH	YCX0315-001AH
 <p>NVM</p>	Male	Crimp Coaxial for RG316	NVMRTH	YCX0315-004H
		Crimp Coaxial for RG316DB	NVMR1TH	YCX0315-018H
 <p>NVM</p>	Male	Solder Coaxial for RG405 or T-Flex 405	NVMSTH	YCX0315-003H
 <p>NVF</p>	Female	Straight Dip Coax	NVFDTAH	Fixed Contacts cannot be removed

Notes: 1. Please request specs from our customer service department. Dimensions are in inches [mm].

Module Accessories

	Crimp Tool	Crimp Die Set	Crimp Positioner	Insertion Tool	Extraction Tool
Module H					
Female Male	AFM8 or M22520/2-01	—	T1974 T1973	T1970	—
Module K					
Style R Style RR Jacket of H2	AFM8	—	K547 K547-2 K640	—	S/DEM1.0060
Module P					
All Styles	AFM8	—	K623-1	—	S/DEM1.0060
Module T					
All Styles	AF8	—	TP687	—	S/DEM5.0150
Module V					
All Styles	M309	—	T1981	—	T1982
Module V Coax					
Center Conductor Outer Conductor	AFM8 HX3	— T1958 for RG316 or T2019 for RG316DB	T1957 —	—	T1982

Mounting Dimensions

Single Row Frame Mounting

For Frame Type B, BV, BY, JV & JY

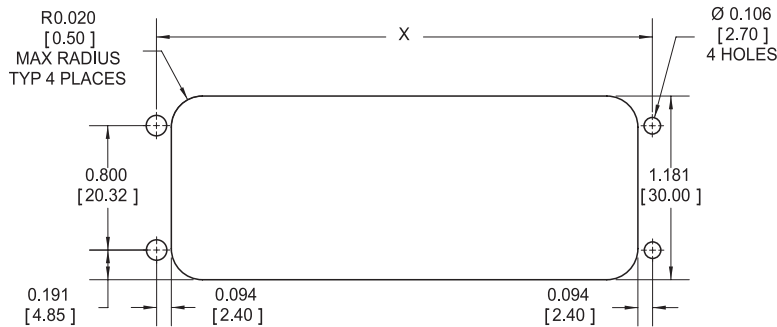

UNITS	X
7	1.000 [25.40]
11	1.400 [35.65]
15	1.800 [45.72]
19	2.200 [55.88]
23	2.600 [66.04]
27	3.000 [76.20]
31	3.400 [86.36]
35	3.800 [96.52]
45	4.800 [121.90]

Float Mounting

For Frame Type H

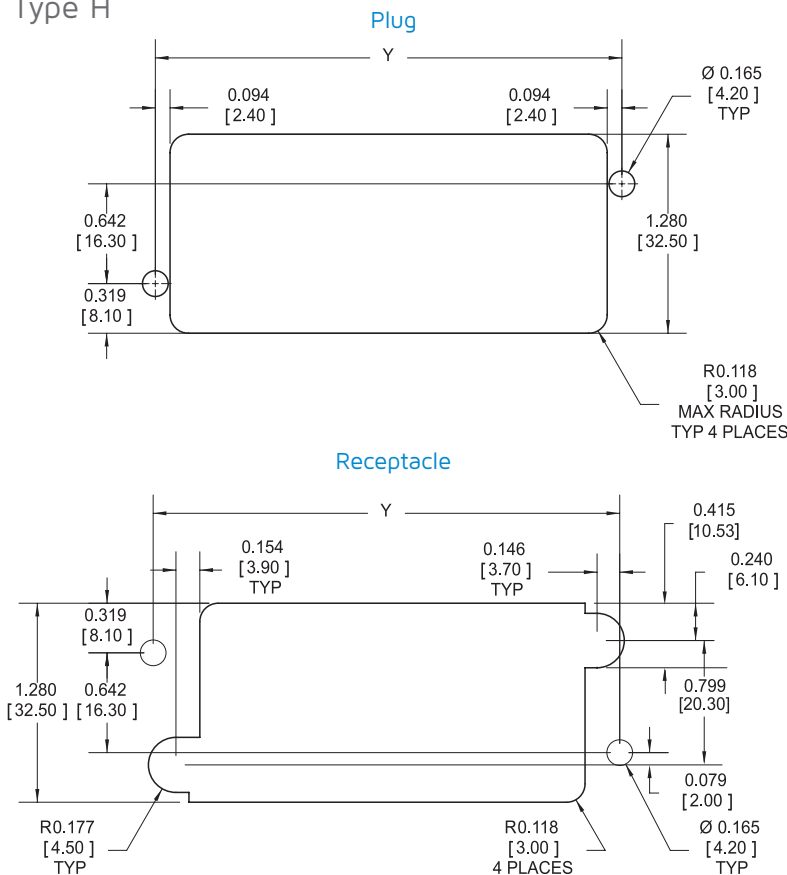

UNITS	Y
7	2.000 [50.80]
11	2.400 [60.96]
15	2.800 [71.12]
19	3.200 [81.28]
23	3.600 [91.44]
27	4.000 [101.60]
31	4.400 [111.76]
35	4.800 [121.92]
45	5.800 [147.32]

Notes: 1. 59.0 oz. in. torque for mounting. 2. Refer to individual frame type for standard length. Dimensions are in inches [mm].

How To Order



1 N Series [Fixed]

2 Insulator	P Plug E Receptacle
3 Frame Type	B Frame B BV Frame BV BY Frame BY H Frame H JV Frame JV JY Frame JY
4 Frame Length	4 to 20 Units ⁽²⁾ Frame length is computed by multiplying the module units by module quantity and totaling the results. Apply 2 additional units for frames with Jackscrews.
5 Module Quantity + Part Number	4 + AMST / 2 + CHT / Amount of same modules together within frame. (Drop "N" from beginning of module part number, see pg. 12 for all module part numbers). Example: 4AMST = 4 of the (L)AMST style modules. Separate each series of modules by "/". Modules will be positioned in frame according to sequence listed.
6 Plating	T 10 µin GOLD OVER NICKEL TH 50 µin GOLD OVER NICKEL TAH 50 µin GOLD OVER NICKEL

Notes: 1. When part number exceeds 24 characters, please consult factory for special (abbreviated) part number. 2. The plug frame has a built in pin shroud (sockets may be used in plug frames, but not recommended). 3. Consult factory when ordering straight dip solder tails with center jacking version. Special cut out and modification - 872 is required. Dimensions are in inches [mm].

Global Support

UK Headquarters

- London, UK
+44 20 7004 1600
info.uk@smithsinterconnect.com

US Headquarters

- Stuart, FL
+1 772 286 9300
info.us@smithsinterconnect.com

Americas

- Costa Mesa, CA
+1 714 371 1100
info.us@smithsinterconnect.com
- Milpitas, CA
+1 408 957 9607 x-1125
info.us@smithsinterconnect.com
- Stuart, FL
+1 772 286 9300
info.us@smithsinterconnect.com
- Hudson, MA
+1 978 568 0451
info.us@smithsinterconnect.com
- Northampton, MA
+1 413 582 9620
info.northamptonsmithsinterconnectinc.com
- Tampa, FL
+ 1 813 901 7200
info.tampa@smithsinterconnectinc.com
- Kansas City, KS
+1 913 342 5544
info.us@smithsinterconnect.com
- Salisbury, MD
+1 800 780 2169
info.us@smithsinterconnect.com
- Thousand Oaks, CA
+1 805 267 0100
info.thousandoaks@smithsinterconnectinc.com

Europe

- Deggendorf, Germany
+49 991 250 120
info.de@smithsinterconnect.com
- Genova, Italy
+39 0 10 60361
info.it@smithsinterconnect.com
- Dundee, UK
+44 1382 427 200
info.dundee@smithsinterconnect.com
- Rouen, France
+33 2 32 96 91 76
info.fr@smithsinterconnect.com
- Elstree, UK
+44 20 8236 2400
info.uk@smithsinterconnect.com

Asia

- Shanghai, China
+86 21 3318 4650
asiainfo@smithsinterconnect.com
- Suzhou, China
+86 512 6273 1188
asiainfo@smithsinterconnect.com
- Singapore
+65 6846 1655
asiainfo@smithsinterconnect.com

more > smithsinterconnect.com

