

Power

Channel



**CONTRINEX**



# SAFETINEX

SAFETY LIGHT CURTAINS



## SAFETINEX SAFETY LIGHT CURTAINS

## CONTRINEX

Contrinex, a multinational company with headquarters in Switzerland, is specialized in the development, production and worldwide sales of industrial sensing equipment. At the present time, Contrinex has over 400 employees, operates production units in Switzerland, Hungary and China, has its own sales offices in all the major markets, and is represented in over 50 countries. Contrinex applies stringent management and production principles which are reflected in its ISO 14001:2004 and ISO 9001:2000 certification. Additionally Contrinex is subject to several client-based audits every year. Identical quality controls and equipment as well as staff recruitment and training policies are implemented at the different production sites, thus guaranteeing consistent product quality.



## SAFETINEX SAFETY SYSTEMS

The Safetinx product line produced by Contrinex offers high-quality safeguarding solutions for both personnel and machinery. The range of safety light curtains comprises highly sensitive type-4 devices for finger and hand protection, with various lengths and connection options.

Safetinx products have been developed in compliance with the applicable international safety standards and have obtained the required product certification for use in the European Union, the United States of America and all other countries where the applicable IEC standards have been adopted. Safetinx light curtains feature the highest safety level, i.e. they correspond to safety category 4 according to ISO 13849-1 (former EN 954-1) and type 4 according to IEC 61496-1 and -2. They have successfully obtained the highly rated TÜV certification.



## ACTIVE OPTOELECTRONIC PROTECTIVE DEVICES

When looking to build a safety system around a danger zone, the first consideration is whether or not optical protection is suitable at all. For this to be the case, it must be possible for the machine control to be electrically influenced by means of the light curtain's semiconductor output. Moreover, it must also be possible to instantly terminate or exit the hazardous process in every operating phase. Further, there must be no danger of injury due to heat, radiation or from materials or components ejected by the machine. If such danger exists, then either the optical system is not suitable, or the danger must be otherwise excluded by applying additional safety measures.

The selection of a specific safeguarding measure involves an evaluation of the hazard, in order to determine the applicable safety type/category and resolution of the protective device.

## SAFEGUARDING FUNCTION

The safety light curtain resolution must be chosen according to the application and the required safeguarding function. It is defined as the minimum size of an object that can be reliably and safely detected at any position when placed in the protective field. The choice of a specific resolution depends on the part of the body which needs protection (finger, hand or whole body). In all cases, the primary function of the protective device is to stop the machine before the hazardous point is reached and to prevent unintentional machine start-up. This function must comply with the category of the safety-related components of the machine's control system.



## OPERATING PRINCIPLE

The Safetinex YBB light curtains operate with infrared beams. When the light curtain detects a finger or hand entering the defined hazardous area, the protective equipment immediately stops the machine, or renders it harmless. When operating in manual restart mode, the reset button enabling the operator to restart the machine must be located outside the hazardous area. From there, the operator must have a full view of the hazardous area to make sure that nobody is in danger before restarting the machine.

Safetinex light curtains are designed to ensure protection of operators working in hazardous areas. A high reliability is achieved by implementing a fail-safe system: Type 4 safety light curtains are thus permanently self-controlled. An internal failure immediately deactivates the output signals, as would an intrusion into the protective field.

## APPLICATION AREAS

The Safetinex YBB range is best suited where finger and hand protection is required close to the hazardous area (point of operation). Depending on the application, a resolution of either 14 mm (finger protection) or 30 mm (hand protection) will be advisable.

Thanks to their category/type 4 safety level, these light curtains can be used on equipment requiring high protection reliability, such as machine tools, robots, hydraulic presses, automated stock management, weaving looms, etc.



## FINGER PROTECTION 14 MM

## MAIN FEATURES

- Resolution: 14 mm
- Operating range: 0.25 ... 3.5 m
- Protective height: 137 ... 1685 mm
- Category 4 according to ISO 13849-1 (former EN 954-1)
- Type 4 according to IEC 61496-1 and -2
- 2-channel selection
- Optical synchronization
- Permanent autocontrol

## TECHNICAL DATA

Dimensions	42 x 48 x Ht mm
Supply voltage range	24 VDC ± 20 %
Current consumption sender	50 mA max. / 1.5 W max.
Current consumption receiver (excl. load)	160 mA max. / 4.7 W max.
Output current	0.2 A max. per output
Safety level	Type 4 (EN/IEC 61496-1 and -2)
	Category 4 (EN/ISO 13849-1)
Protection class	III (IEC 61140)
Ambient temperature range	0 ... +50 °C
Storage temperature range	-25 ... +70 °C
Degree of protection	IP 65 (EN 60529)
Housing material	Aluminum
Material of optics	PMMA
Operating range	0.25 ... 3.5 m
Sender wavelength	IR 950 nm

## HOUSING

Aluminum profile 42 x 48 mm coated with yellow epoxy finish. Dual fixing groove.

## ELECTRONIC PROTECTION

Safetinex light curtains are self-protected against overloads and short-circuits. They can also withstand short high-voltage overloads.

## CONNECTION

Safetinex light curtains are available with M12 5-pole or M26 7-pole connector, short cable (pig-tail) with M12 connector or PUR cable, 2 m, 5 m or 10 m long.

## DOCUMENTATION

Detailed data sheets for these products can be found on the Contrinex website [www.contrinex.com](http://www.contrinex.com) or ordered free of charge from our distributors.

## LEDS

LED indicators on the YBB **sender** unit

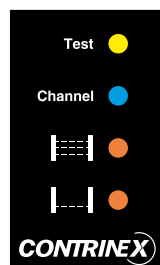

- Test : yellow when test mode is active
- Channel : blue when channel 1 is selected  
purple when channel 2 is selected
- Alignment : steady orange when the screen is not fully aligned  
flashing orange when the first third of the screen is aligned  
off when screen is fully aligned
- Alignment : steady orange when the lowest beam is not aligned  
flashing orange when the lowest beam is aligned  
off when screen is fully aligned

LED indicators on the YBB **receiver** unit

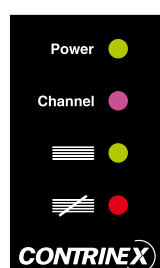

- Power : green when power is ON
- Channel : blue when channel 1 is selected  
purple when channel 2 is selected
- Status : green when OSSD outputs are ON
- Status : red when OSSD outputs are OFF

## DIMENSIONS

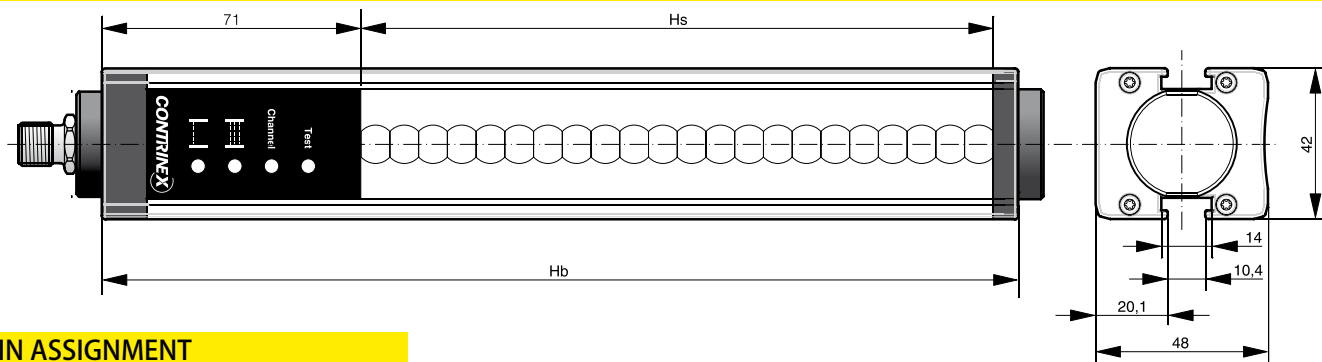

## PIN ASSIGNMENT

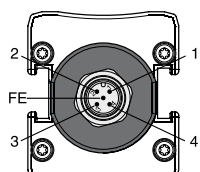

M12 connector

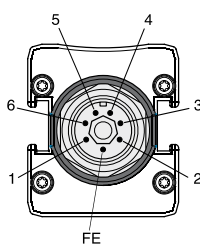

M26 connector



Pigtail M12

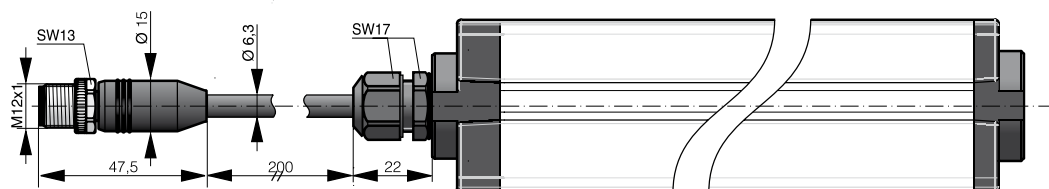

YBB-14...-G012

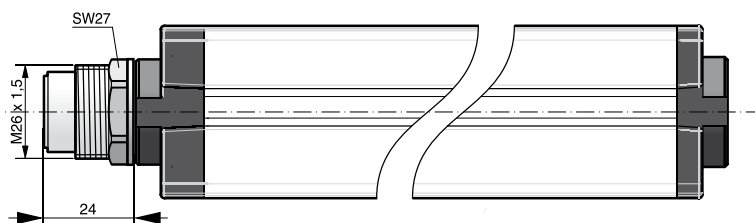

YBB-14...-G026

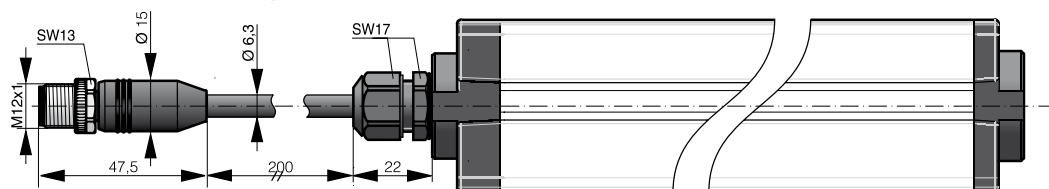

YBB-14...-P012

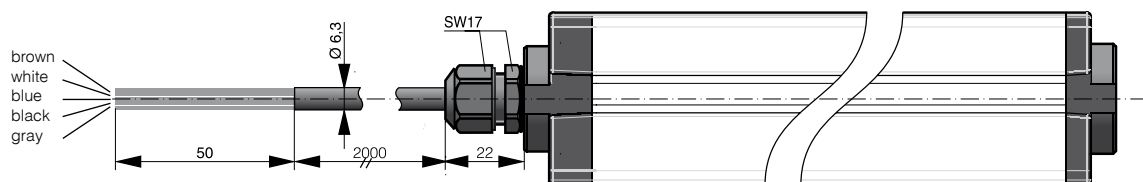

YBB-14...-D020

Cable

ASSIGNMENT	FUNCTION	PINS/WIRES ON SENDER			PINS/WIRES ON RECEIVER		
		M12 / PIGTAIL	M26	CABLE	M12 / PIGTAIL	M26	CABLE
Supply voltage	24 VDC for channel 1 / 0 V for channel 2	1	1	brown	1	1	brown
Supply voltage	0 V for channel 1 / 24 VDC for channel 2	3	2	blue	3	2	blue
Test mode	0 V: test active / 24 V: test inactive	4	3	black	-	-	-
Output	OSSD1	-	-	-	2	3	white
Output	OSSD2	-	-	-	4	4	black
Functional earth	Shield	FE	FE	gray	FE	FE	gray



## FINGER PROTECTION (14 MM) AVAILABLE MODELS

### TYPE SPECIFIC DATA

Type	0150	0250	0400
Total height (Ht) [mm] *	245	374	503
Housing height (Hb) [mm]*	215	344	473
Protective height (Hs) [mm]	137	266	395
Number of beams	17	33	49
Response time [ms]	5.2	8.4	11.6
Current consumption [mA]	135	140	145

### PART REFERENCES

PNP / Connector M12	Sender	YBB-14S4-0150-G012	YBB-14S4-0250-G012	YBB-14S4-0400-G012
	Receiver	YBB-14R4-0150-G012	YBB-14R4-0250-G012	YBB-14R4-0400-G012
PNP / Connector M26	Sender	YBB-14S4-0150-G026	YBB-14S4-0250-G026	YBB-14S4-0400-G026
	Receiver	YBB-14R4-0150-G026	YBB-14R4-0250-G026	YBB-14R4-0400-G026
PNP / Pigtail M12	Sender	YBB-14S4-0150-P012	YBB-14S4-0250-P012	YBB-14S4-0400-P012
	Receiver	YBB-14R4-0150-P012	YBB-14R4-0250-P012	YBB-14R4-0400-P012
PNP / PUR cable 2 m	Sender	YBB-14S4-0150-D020	YBB-14S4-0250-D020	YBB-14S4-0400-D020
	Receiver	YBB-14R4-0150-D020	YBB-14R4-0250-D020	YBB-14R4-0400-D020
PNP / PUR cable 5 m	Sender	YBB-14S4-0150-D050	YBB-14S4-0250-D050	YBB-14S4-0400-D050
	Receiver	YBB-14R4-0150-D050	YBB-14R4-0250-D050	YBB-14R4-0400-D050
PNP / PUR cable 10 m	Sender	YBB-14S4-0150-D100	YBB-14S4-0250-D100	YBB-14S4-0400-D100
	Receiver	YBB-14R4-0150-D100	YBB-14R4-0250-D100	YBB-14R4-0400-D100

### TYPE SPECIFIC DATA

Type	1000	1200	1300
Total height (Ht) [mm] *	1148	1277	1406
Housing height (Hb) [mm]*	1118	1247	1376
Protective height (Hs) [mm]	1040	1169	1298
Number of beams	129	145	161
Response time [ms]	27.6	30.8	34
Current consumption [mA]	175	185	190

### PART REFERENCES

PNP / Connector M12	Sender	YBB-14S4-1000-G012	YBB-14S4-1200-G012	YBB-14S4-1300-G012
	Receiver	YBB-14R4-1000-G012	YBB-14R4-1200-G012	YBB-14R4-1300-G012
PNP / Connector M26	Sender	YBB-14S4-1000-G026	YBB-14S4-1200-G026	YBB-14S4-1300-G026
	Receiver	YBB-14R4-1000-G026	YBB-14R4-1200-G026	YBB-14R4-1300-G026
PNP / Pigtail M12	Sender	YBB-14S4-1000-P012	YBB-14S4-1200-P012	YBB-14S4-1300-P012
	Receiver	YBB-14R4-1000-P012	YBB-14R4-1200-P012	YBB-14R4-1300-P012
PNP / PUR cable 2 m	Sender	YBB-14S4-1000-D020	YBB-14S4-1200-D020	YBB-14S4-1300-D020
	Receiver	YBB-14R4-1000-D020	YBB-14R4-1200-D020	YBB-14R4-1300-D020
PNP / PUR cable 5 m	Sender	YBB-14S4-1000-D050	YBB-14S4-1200-D050	YBB-14S4-1300-D050
	Receiver	YBB-14R4-1000-D050	YBB-14R4-1200-D050	YBB-14R4-1300-D050
PNP / PUR cable 10 m	Sender	YBB-14S4-1000-D100	YBB-14S4-1200-D100	YBB-14S4-1300-D100
	Receiver	YBB-14R4-1000-D100	YBB-14R4-1200-D100	YBB-14R4-1300-D100

\* Total height given with M12 connector. For M26 add 8 mm. For cable add 6 mm.

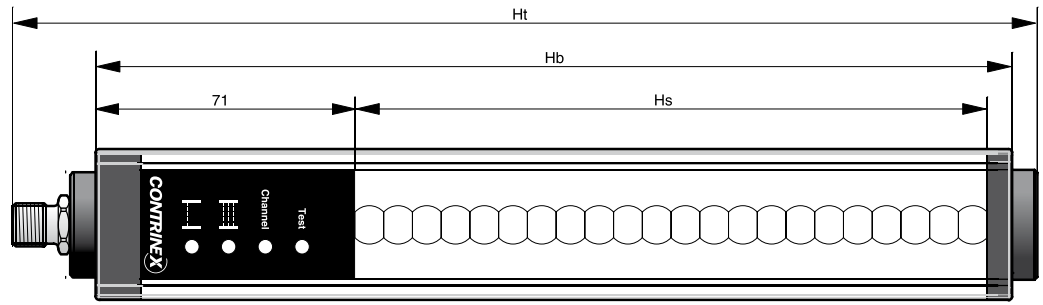

0500	0700	0800	0900
632	761	890	1019
602	731	860	989
524	653	782	911
65	81	97	113
14.8	18	21.2	24.4
150	160	165	170

YBB-14S4-0500-G012	YBB-14S4-0700-G012	YBB-14S4-0800-G012	YBB-14S4-0900-G012
YBB-14R4-0500-G012	YBB-14R4-0700-G012	YBB-14R4-0800-G012	YBB-14R4-0900-G012
YBB-14S4-0500-G026	YBB-14S4-0700-G026	YBB-14S4-0800-G026	YBB-14S4-0900-G026
YBB-14R4-0500-G026	YBB-14R4-0700-G026	YBB-14R4-0800-G026	YBB-14R4-0900-G026
YBB-14S4-0500-P012	YBB-14S4-0700-P012	YBB-14S4-0800-P012	YBB-14S4-0900-P012
YBB-14R4-0500-P012	YBB-14R4-0700-P012	YBB-14R4-0800-P012	YBB-14R4-0900-P012
YBB-14S4-0500-D020	YBB-14S4-0700-D020	YBB-14S4-0800-D020	YBB-14S4-0900-D020
YBB-14R4-0500-D020	YBB-14R4-0700-D020	YBB-14R4-0800-D020	YBB-14R4-0900-D020
YBB-14S4-0500-D050	YBB-14S4-0700-D050	YBB-14S4-0800-D050	YBB-14S4-0900-D050
YBB-14R4-0500-D050	YBB-14R4-0700-D050	YBB-14R4-0800-D050	YBB-14R4-0900-D050
YBB-14S4-0500-D100	YBB-14S4-0700-D100	YBB-14S4-0800-D100	YBB-14S4-0900-D100
YBB-14R4-0500-D100	YBB-14R4-0700-D100	YBB-14R4-0800-D100	YBB-14R4-0900-D100

1400	1600	1700
1535	1664	1793
1505	1634	1763
1427	1556	1685
177	193	209
37.2	40.4	43.6
195	200	210



YBB-14S4-1400-G012	YBB-14S4-1600-G012	YBB-14S4-1700-G012
YBB-14R4-1400-G012	YBB-14R4-1600-G012	YBB-14R4-1700-G012
YBB-14S4-1400-G026	YBB-14S4-1600-G026	YBB-14S4-1700-G026
YBB-14R4-1400-G026	YBB-14R4-1600-G026	YBB-14R4-1700-G026
YBB-14S4-1400-P012	YBB-14S4-1600-P012	YBB-14S4-1700-P012
YBB-14R4-1400-P012	YBB-14R4-1600-P012	YBB-14R4-1700-P012
YBB-14S4-1400-D020	YBB-14S4-1600-D020	YBB-14S4-1700-D020
YBB-14R4-1400-D020	YBB-14R4-1600-D020	YBB-14R4-1700-D020
YBB-14S4-1400-D050	YBB-14S4-1600-D050	YBB-14S4-1700-D050
YBB-14R4-1400-D050	YBB-14R4-1600-D050	YBB-14R4-1700-D050
YBB-14S4-1400-D100	YBB-14S4-1600-D100	YBB-14S4-1700-D100
YBB-14R4-1400-D100	YBB-14R4-1600-D100	YBB-14R4-1700-D100





**HAND PROTECTION  
30 MM**

## MAIN FEATURES

- Resolution: 30 mm
- Operating range: 0.25 ... 12 m
- Protective height: 274 ... 1822 mm
- Category 4 according to ISO 13849-1 (former EN 954-1)
- Type 4 according to IEC 61496-1 and -2
- 2-channel selection
- Optical synchronization
- Permanent autocontrol

## TECHNICAL DATA

Dimensions	42 x 48 x Ht mm
Supply voltage range	24 VDC ± 20 %
Current consumption sender	50 mA max. / 1.5 W max.
Current consumption receiver (excl. load)	160 mA max. / 4.7 W max.
Output current	0.2 A max. per output
Safety level	Type 4 (EN/IEC 61496-1 and -2)
	Category 4 (EN/ISO 13849-1)
Protection class	III (IEC 61140)
Ambient temperature range	0 ... +50 °C
Storage temperature range	-25 ... +70 °C
Degree of protection	IP 65 (EN 60529)
Housing material	Aluminum
Material of optics	PMMA
Operating range	0.25 ... 12 m
Sender wavelength	IR 880 nm

## HOUSING

Aluminum profile 42 x 48 mm coated with yellow epoxy finish. Dual fixing groove.

## ELECTRONIC PROTECTION

Safetinx light curtains are self-protected against overloads and short-circuits. They can also withstand short high-voltage overloads.

## CONNECTION

Safetinx light curtains are available with M12 5-pole or M26 7-pole connector, short cable (pig-tail) with M12 connector or PUR cable, 2 m, 5 m or 10 m long.

## DOCUMENTATION

Detailed data sheets for these products can be found on the Contrinex website [www.contrinex.com](http://www.contrinex.com) or ordered free of charge from our distributors.

## LEDS

LED indicators on the YBB **sender** unit

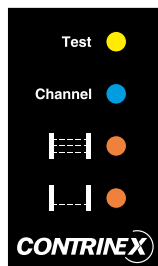

- Test : yellow when test mode is active
- Channel : blue when channel 1 is selected  
purple when channel 2 is selected
- Alignment : steady orange when the screen is not fully aligned  
flashing orange when the first third of the screen is aligned  
off when screen is fully aligned
- Alignment : steady orange when the lowest beam is not aligned  
flashing orange when the lowest beam is aligned  
off when screen is fully aligned

LED indicators on the YBB **receiver** unit

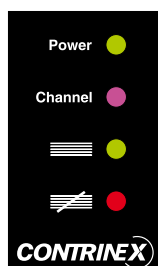

- Power : green when power is ON
- Channel : blue when channel 1 is selected  
purple when channel 2 is selected
- Status : green when OSSD outputs are ON
- Status : red when OSSD outputs are OFF

## DIMENSIONS

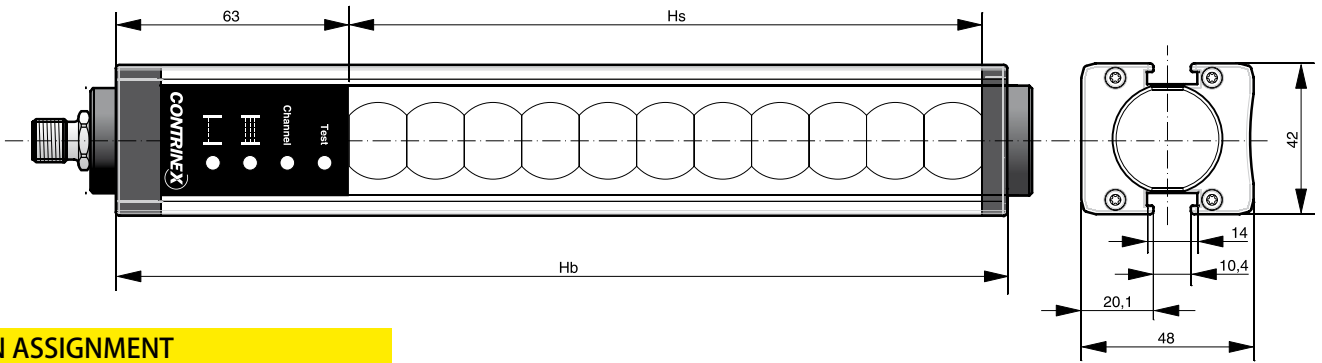

## PIN ASSIGNMENT

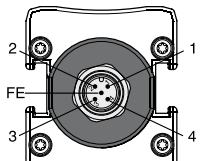

M12 connector

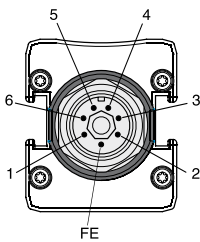

M26 connector



Pigtail M12

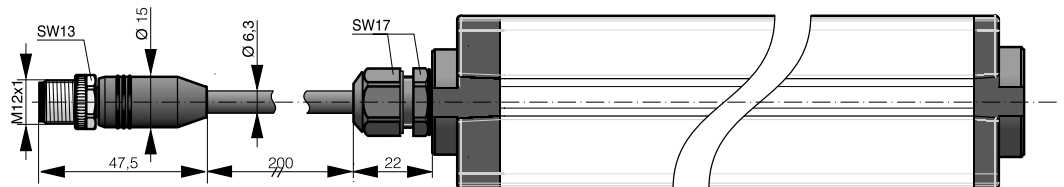

YBB-30...-G012

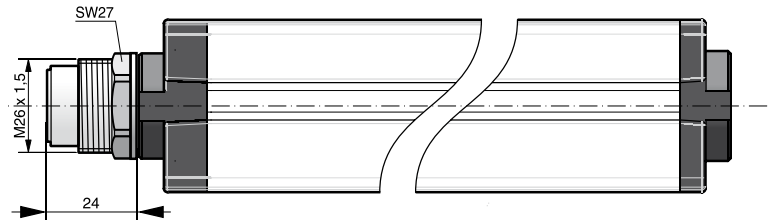

YBB-30...-G026

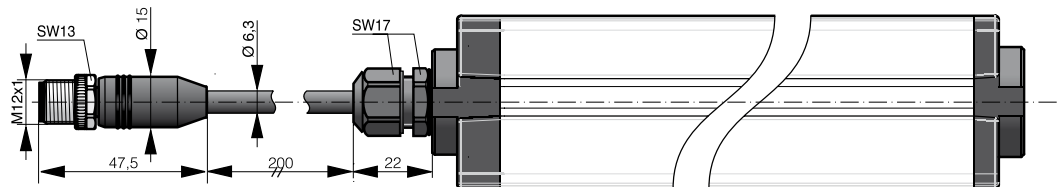

YBB-30...-P012

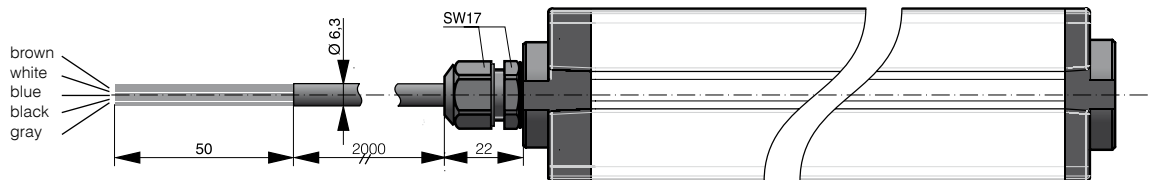

YBB-30...-D020

ASSIGNMENT	FUNCTION	PINS/WIRES ON SENDER			PINS/WIRES ON RECEIVER		
		M12 / PIGTAIL	M26	CABLE	M12 / PIGTAIL	M26	CABLE
Supply voltage	24 VDC for channel 1 / 0 V for channel 2	1	1	brown	1	1	brown
Supply voltage	0 V for channel 1 / 24 VDC for channel 2	3	2	blue	3	2	blue
Test mode	0 V: test active / 24 V: test inactive	4	3	black	-	-	-
Output	OSSD1	-	-	-	2	3	white
Output	OSSD2	-	-	-	4	4	black
Functional earth	Shield	FE	FE	gray	FE	FE	gray



## HAND PROTECTION (30 MM) AVAILABLE MODELS

### TYPE SPECIFIC DATA

Type	0250	0400	0500
Total height (Ht) [mm] *	374	503	632
Housing height (Hb) [mm]*	344	473	602
Protective height (Hs) [mm]	274	403	532
Number of beams	17	25	33
Response time [ms]	5.2	6.8	8.4
Current consumption [mA]	125	130	130

### PART REFERENCES

PNP / Connector M12	Sender	YBB-30S4-0250-G012	YBB-30S4-0400-G012	YBB-30S4-0500-G012
	Receiver	YBB-30R4-0250-G012	YBB-30R4-0400-G012	YBB-30R4-0500-G012
PNP / Connector M26	Sender	YBB-30S4-0250-G026	YBB-30S4-0400-G026	YBB-30S4-0500-G026
	Receiver	YBB-30R4-0250-G026	YBB-30R4-0400-G026	YBB-30R4-0500-G026
PNP / Pigtail M12	Sender	YBB-30S4-0250-P012	YBB-30S4-0400-P012	YBB-30S4-0500-P012
	Receiver	YBB-30R4-0250-P012	YBB-30R4-0400-P012	YBB-30R4-0500-P012
PNP / PUR cable 2 m	Sender	YBB-30S4-0250-D020	YBB-30S4-0400-D020	YBB-30S4-0500-D020
	Receiver	YBB-30R4-0250-D020	YBB-30R4-0400-D020	YBB-30R4-0500-D020
PNP / PUR cable 5 m	Sender	YBB-30S4-0250-D050	YBB-30S4-0400-D050	YBB-30S4-0500-D050
	Receiver	YBB-30R4-0250-D050	YBB-30R4-0400-D050	YBB-30R4-0500-D050
PNP / PUR cable 10 m	Sender	YBB-30S4-0250-D100	YBB-30S4-0400-D100	YBB-30S4-0500-D100
	Receiver	YBB-30R4-0250-D100	YBB-30R4-0400-D100	YBB-30R4-0500-D100

### TYPE SPECIFIC DATA

Type	1200	1300	1400
Total height (Ht) [mm] *	1277	1406	1535
Housing height (Hb) [mm]*	1247	1376	1505
Protective height (Hs) [mm]	1177	1306	1435
Number of beams	73	81	89
Response time [ms]	16.4	18	19.6
Current consumption [mA]	150	155	160

### PART REFERENCES

PNP / Connector M12	Sender	YBB-30S4-1200-G012	YBB-30S4-1300-G012	YBB-30S4-1400-G012
	Receiver	YBB-30R4-1200-G012	YBB-30R4-1300-G012	YBB-30R4-1400-G012
PNP / Connector M26	Sender	YBB-30S4-1200-G026	YBB-30S4-1300-G026	YBB-30S4-1400-G026
	Receiver	YBB-30R4-1200-G026	YBB-30R4-1300-G026	YBB-30R4-1400-G026
PNP / Pigtail M12	Sender	YBB-30S4-1200-P012	YBB-30S4-1300-P012	YBB-30S4-1400-P012
	Receiver	YBB-30R4-1200-P012	YBB-30R4-1300-P012	YBB-30R4-1400-P012
PNP / PUR cable 2 m	Sender	YBB-30S4-1200-D020	YBB-30S4-1300-D020	YBB-30S4-1400-D020
	Receiver	YBB-30R4-1200-D020	YBB-30R4-1300-D020	YBB-30R4-1400-D020
PNP / PUR cable 5 m	Sender	YBB-30S4-1200-D050	YBB-30S4-1300-D050	YBB-30S4-1400-D050
	Receiver	YBB-30R4-1200-D050	YBB-30R4-1300-D050	YBB-30R4-1400-D050
PNP / PUR cable 10 m	Sender	YBB-30S4-1200-D100	YBB-30S4-1300-D100	YBB-30S4-1400-D100
	Receiver	YBB-30R4-1200-D100	YBB-30R4-1300-D100	YBB-30R4-1400-D100

\* Total height given with M12 connector. For M26 add 8 mm. For cable add 6 mm.

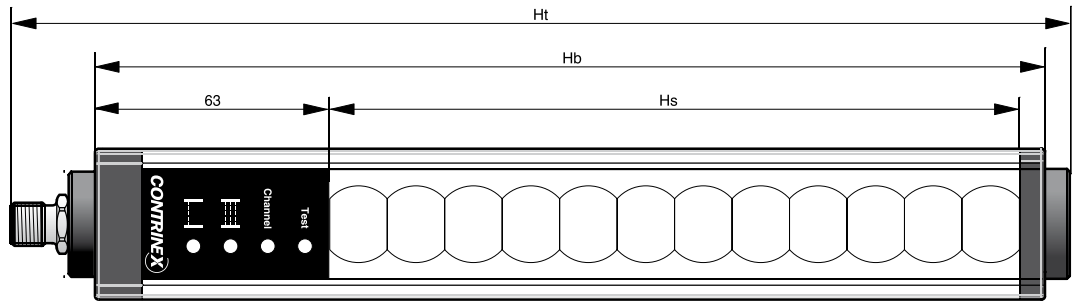

0700	0800	0900	1000
761	890	1019	1148
731	860	989	1118
661	790	919	1048
41	49	57	65
10	11.6	13.2	14.8
135	140	140	145

YBB-30S4-0700-G012	YBB-30S4-0800-G012	YBB-30S4-0900-G012	YBB-30S4-1000-G012
YBB-30R4-0700-G012	YBB-30R4-0800-G012	YBB-30R4-0900-G012	YBB-30R4-1000-G012
YBB-30S4-0700-G026	YBB-30S4-0800-G026	YBB-30S4-0900-G026	YBB-30S4-1000-G026
YBB-30R4-0700-G026	YBB-30R4-0800-G026	YBB-30R4-0900-G026	YBB-30R4-1000-G026
YBB-30S4-0700-P012	YBB-30S4-0800-P012	YBB-30S4-0900-P012	YBB-30S4-1000-P012
YBB-30R4-0700-P012	YBB-30R4-0800-P012	YBB-30R4-0900-P012	YBB-30R4-1000-P012
YBB-30S4-0700-D020	YBB-30S4-0800-D020	YBB-30S4-0900-D020	YBB-30S4-1000-D020
YBB-30R4-0700-D020	YBB-30R4-0800-D020	YBB-30R4-0900-D020	YBB-30R4-1000-D020
YBB-30S4-0700-D050	YBB-30S4-0800-D050	YBB-30S4-0900-D050	YBB-30S4-1000-D050
YBB-30R4-0700-D050	YBB-30R4-0800-D050	YBB-30R4-0900-D050	YBB-30R4-1000-D050
YBB-30S4-0700-D100	YBB-30S4-0800-D100	YBB-30S4-0900-D100	YBB-30S4-1000-D100
YBB-30R4-0700-D100	YBB-30R4-0800-D100	YBB-30R4-0900-D100	YBB-30R4-1000-D100

1600	1700	1800
1664	1793	1922
1634	1763	1892
1564	1693	1822
97	105	113
21.2	22.8	24.4
160	165	170



YBB-30S4-1600-G012	YBB-30S4-1700-G012	YBB-30S4-1800-G012
YBB-30R4-1600-G012	YBB-30R4-1700-G012	YBB-30R4-1800-G012
YBB-30S4-1600-G026	YBB-30S4-1700-G026	YBB-30S4-1800-G026
YBB-30R4-1600-G026	YBB-30R4-1700-G026	YBB-30R4-1800-G026
YBB-30S4-1600-P012	YBB-30S4-1700-P012	YBB-30S4-1800-P012
YBB-30R4-1600-P012	YBB-30R4-1700-P012	YBB-30R4-1800-P012
YBB-30S4-1600-D020	YBB-30S4-1700-D020	YBB-30S4-1800-D020
YBB-30R4-1600-D020	YBB-30R4-1700-D020	YBB-30R4-1800-D020
YBB-30S4-1600-D050	YBB-30S4-1700-D050	YBB-30S4-1800-D050
YBB-30R4-1600-D050	YBB-30R4-1700-D050	YBB-30R4-1800-D050
YBB-30S4-1600-D100	YBB-30S4-1700-D100	YBB-30S4-1800-D100
YBB-30R4-1600-D100	YBB-30R4-1700-D100	YBB-30R4-1800-D100





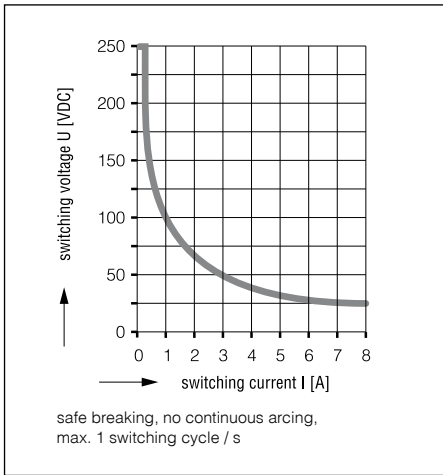

Diagram 1: limit curve for arc-free operation under resistive load

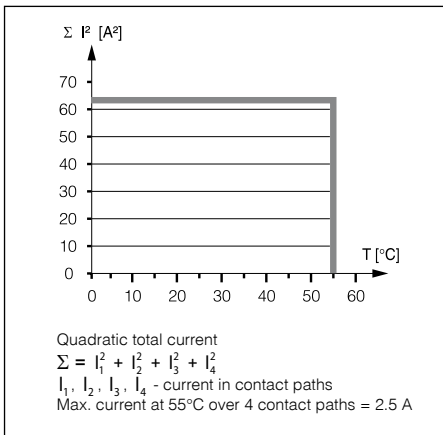
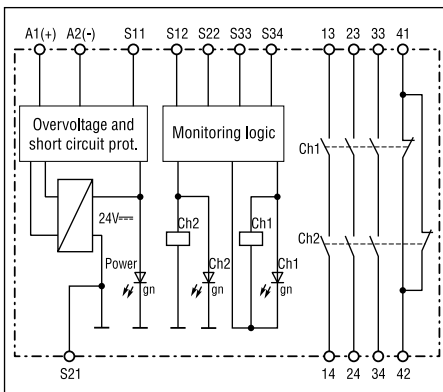

Diagram 2: total current limit curve



Relay block diagram

Wire connection	according to DIN 46 228-1/-2/-3/-4
Screw terminals (integrated)	1 x 4 mm <sup>2</sup> solid or 1 x 2.5 mm <sup>2</sup> stranded ferruled, or 2 x 1.5 mm <sup>2</sup> stranded ferruled, or 2 x 2.5 mm <sup>2</sup> solid
Housing material	thermoplastic, meets UL 94V-0
Housing dimensions (W x H x D)	22.5 x 90 x 121 mm
Mounting	on DIN rail (IEC/EN 60715)
Weight	210 g

## PART REFERENCE

Safety relay	YRB-0131-241
--------------	--------------

### MANUAL RESTART MODE (Channel 1)

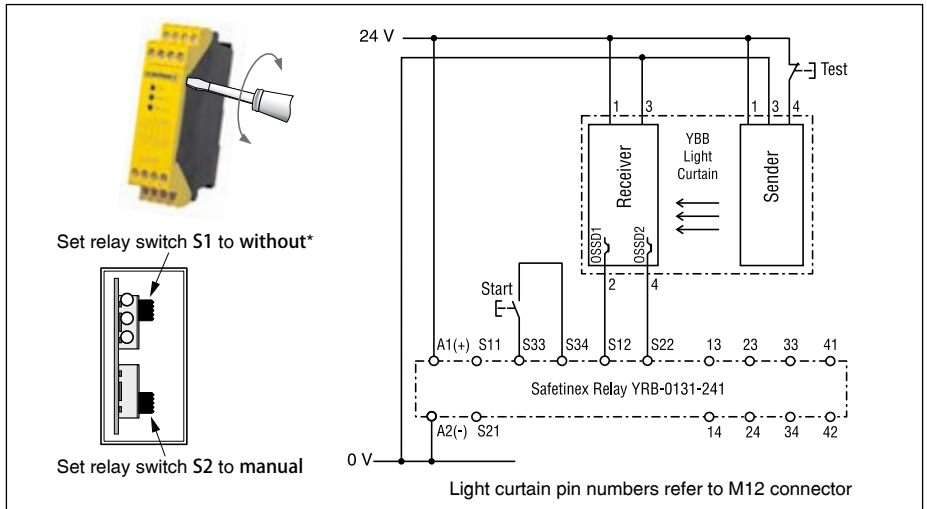

### AUTOMATIC RESTART MODE (Channel 1)

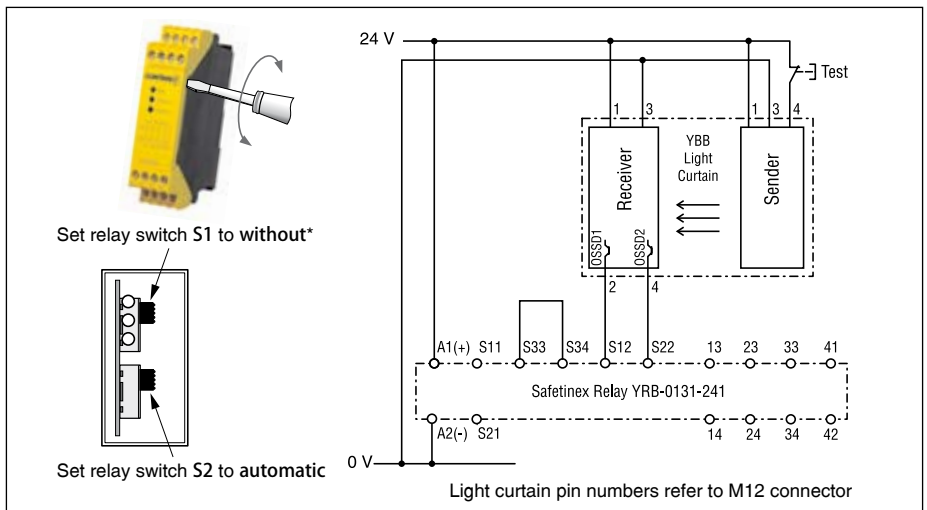

\* Position of switch S1:

- With symmetric outputs on light curtain (such as Safetinx YBB type), set switch S1 to "without".
- With asymmetric outputs on light curtain, set switch S1 to "with".

## ACCESSORIES

### TOP/BOTTOM MOUNTING BRACKET

- Synthetic swivel mounting bracket
- Easy-to-use

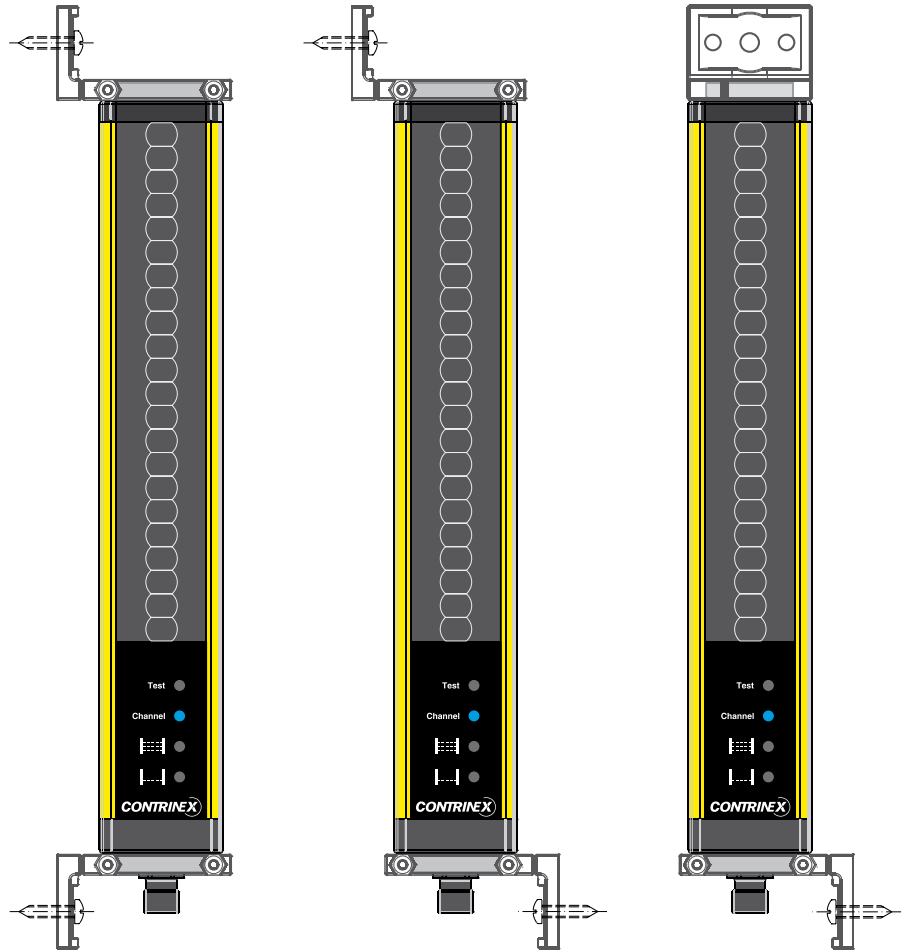

## DIMENSIONS

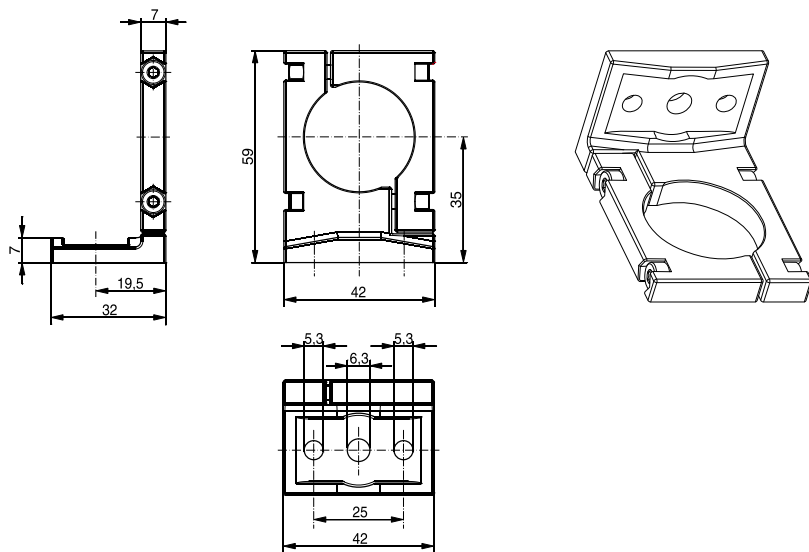

## SLIDING T-NUTS FOR SIDE MOUNTING

A pair of metal sliding T-nuts is supplied with each light curtain unit.

### DIMENSIONS

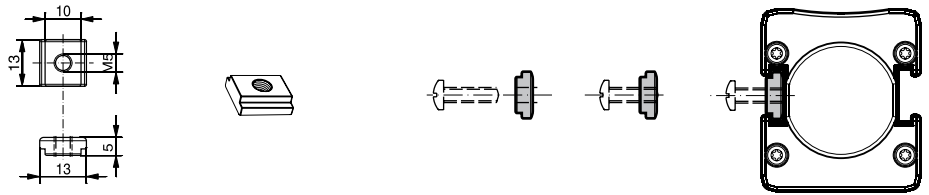

### PART REFERENCES

Top/bottom mounting brackets, synthetic (pair)	YXW-0001-000
T-nuts for side mounting, metal (pair)	YXW-0003-000

## CABLE CONNECTORS

### TECHNICAL DATA

Electromagnetic protection: 4-pole	unshielded
5-pole	shielded
Electrical data (at 20 °C): Nominal voltage	300 V
Test voltage	2000 V
Bending radius for flexible mounting	≥ 10 x cable diameter
Certifications	UL style 11001/21466, CE certified
Wire structure	Fine-stranded conductors 5 x 0.34 mm <sup>2</sup>
Wire diameter	1.5 ± 0.1 mm
Wire insulation	TPM (PP9Y) acc. to DIN VDE 0207-7. RoHS
Wire shore hardness	74 ± 5 D
Wire coating	Polyester foil, wire shield of tin-plated Cu strands
Outer cable diameter	6.3 ± 0.2 mm
Sleeve material	PUR UL/CSA acc. to DIN EN 50363-10-2 (VDE 0207 Part 363-10). RoHS
Sleeve shore hardness	89 ± 5 A
Chemical resistance	Resistant to oil, gasoline and chemicals
Ambient temperature range	-25 ... +80 °C

### PART REFERENCES

PUR, unshielded, S12 4-pole, 2 m	S12-4FUG-020
PUR, unshielded, S12 4-pole, 5 m	S12-4FUG-050
PUR, unshielded, S12 4-pole, 10 m	S12-4FUG-100
PUR, shielded, S12 5-pole, 2 m	S12-5FUG-020-NBSN
PUR, shielded, S12 5-pole, 5 m	S12-5FUG-050-NBSN
PUR, shielded, S12 5-pole, 10 m	S12-5FUG-100-NBSN

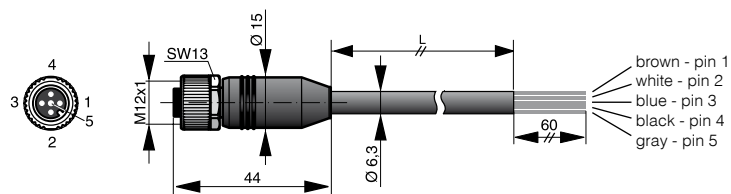



# CONTRINEX

ALL OVER THE WORLD

## EUROPE

Austria  
Belgium  
Croatia  
Czech Republic  
Denmark  
Finland  
France  
Germany  
Great Britain  
Greece  
Hungary  
Ireland  
Italy  
Luxembourg  
Netherlands  
Norway  
Poland  
Portugal  
Romania  
Russian Federation  
Slovakia  
Slovenia

Spain  
Sweden  
Switzerland  
Turkey

## AFRICA

South Africa

## THE AMERICAS

Argentina  
Brazil  
Canada  
Chile  
Colombia  
Mexico  
United States  
Venezuela

## ASIA

China  
India  
Indonesia  
Japan

Korea  
Malaysia  
Pakistan  
Philippines  
Singapore  
Taiwan  
Thailand  
Vietnam

## AUSTRALASIA

Australia  
New Zealand

## MIDDLE EAST

Iran  
Israel  
Syria  
United Arab Emirates

Terms of delivery and right to change design reserved.

**Contrinex AG** Industrial Electronics  
route André Piller 50 - PO Box - CH 1762 Givisiez - Switzerland  
Tel: +41 26 460 46 46 - Fax: +41 26 460 46 40  
Internet: [www.contrinex.com](http://www.contrinex.com) - E-mail: [info@contrinex.com](mailto:info@contrinex.com)